

LIVING now



TRADITIONAL
CONTROL



CONTROL WITH
SMARTPHONE



VOICE
COMMAND



SCHEDULING

bticino

CONTENTS

DESIGN INNOVATION	6
NEW DIGITAL CONTROLS	8
FINISHES	10
THE SOLUTION FOR ALL SYSTEM REQUIREMENTS	16
SMART ELECTRONIC SYSTEM	18
HOME+CONTROL	22
INSTALLATION	28
HOME AUTOMATION THAT SPEAKS	34
HOME AUTOMATION LIKE NEVER BEFORE	36
INSTALLATION OF DIGITAL CONTROLS	40
ALWAYS PERFECT INSTALLATION	44
CATALOGUE	48

LIVING now



Forever an icon,
today smart as well.

Living Now is the new Living generation. A timeless icon which combines the linearity of a unique design with the simplicity of smart technology. All this without changing wiring procedures because Living Now is installed in the traditional way, guaranteeing a perfect installation.

Traditional control	Control with smartphone	Voice command	Scheduling



- **Innovative design:** revisited relationship between cover plate and functions.
- **Smart:** the first intrinsically connected wiring devices range!
- The best technical solutions for a **perfect installation.**

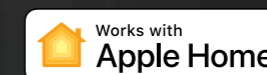

App
Home + Control



DESIGN INNOVATION

PERFECTLY FLUSH WITH
ELEGANT DETAILS

FULL TOUCH CONTROLS
The light can be switched on or off by pressing any point the keys surface. After being pressed, the keys return to their original position, perfectly aligned.



MORE SPACE FOR FUNCTIONS
Unique shape with increased space for functions



Living Now has won the Good Design Award for product design in consumer electronics.



Living Now, has won this prestigious international award confirming BTicino's ability to combine technology and design

NEW DIGITAL CONTROLS WITH LIVING NOW FINISH

Living Now series digital controls are now part of the MyHOME automation range. A mix of incomparable innovation and simplicity, ready to be discovered, heard and touched.



DEVICE FINISHES

WHITE



BLACK



2 COLOUR OPTIONS

Each device features an aesthetic component, its covers which are available in two colours: white and black, each featuring a pleasant satin finish.

COVER PLATES

The Living Now cover plate range includes 12 finishes, made from a range of designer materials including techno polymer metal and wood.



MYHOME DIGITAL CONTROLS

MyHOME digital controls do not require the use of cover plates and are available in white and black.



COVER PLATE FINISHES



ICE cover plate
Material: techno polymer
Code: ...DW



The zamak and wood finishes are obtained using sustainable production procedures. Each coverplate is unique and features distinguishable features making them one-of-a-kind.



GOLD cover plate
Material: zamak
Code: ...ZW



MOON COVER PLATE
Material: zamak
Code: ...NW



SKY cover plate
Material: techno polymer
Code: ...DA



PIXEL cover plate
Material: techno polymer
- pixel effect
Code: ...MW



OAK cover plate
Material: wood
Code: ...LM

COVER PLATE FINISHES

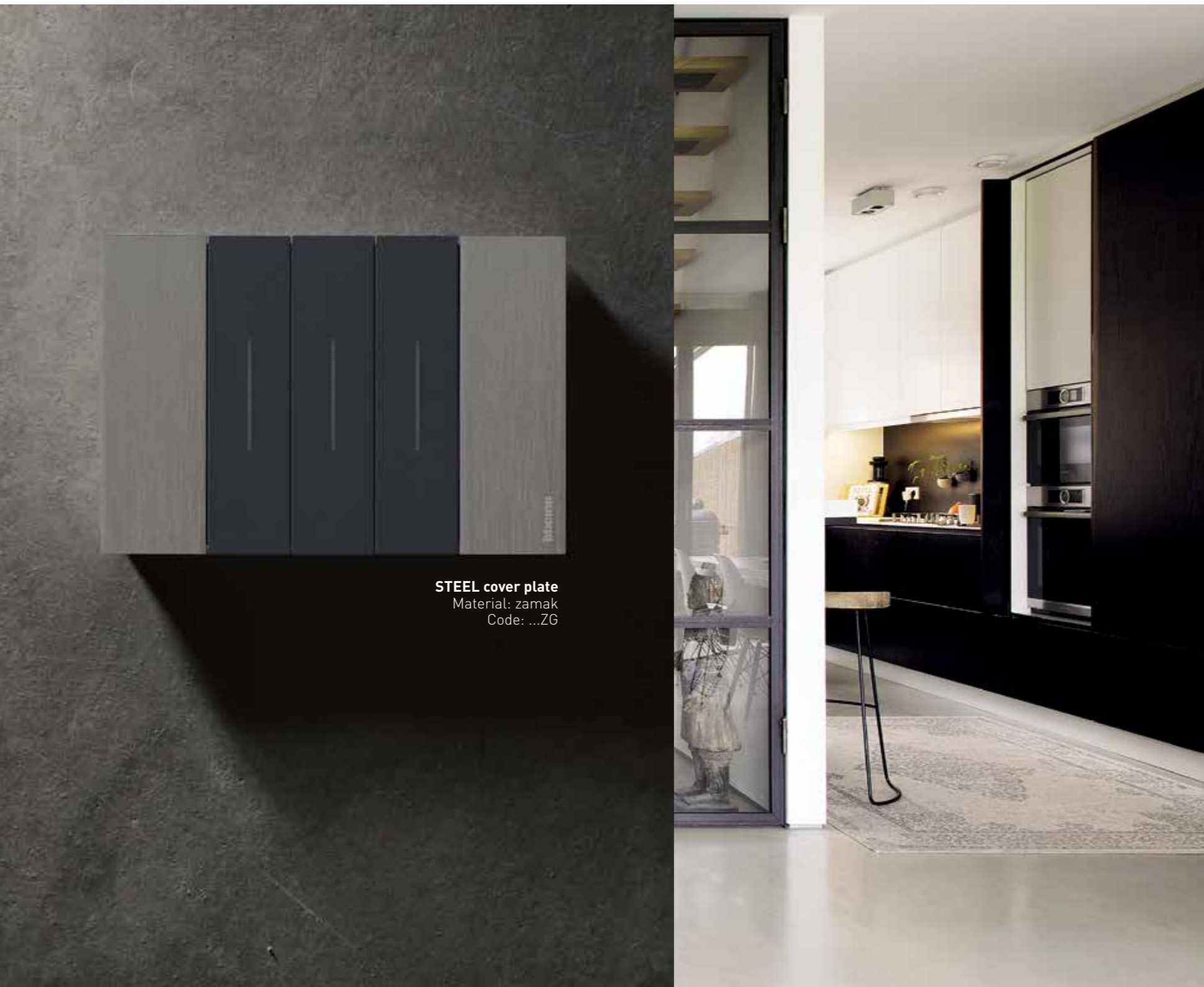

STEEL cover plate
Material: zamak
Code: ...ZG

The zamak and wood finishes are obtained using sustainable production procedures. Each coverplate is unique and features distinguishable features making them one-of-a-kind.



BLACK cover plate
Material: techno polymer
Code: ...KG



SPACE cover plate
Material: zamak
Code: ...NG



WALNUT cover plate
Material: wood
Code: ...LG



NIGHT cover plate
Material: techno polymer
Code: ...DG

THE RIGHT SOLUTION FOR ALL NEEDS

SMART ELECTRICAL SYSTEM

Living Now ^{WITH} Netatmo

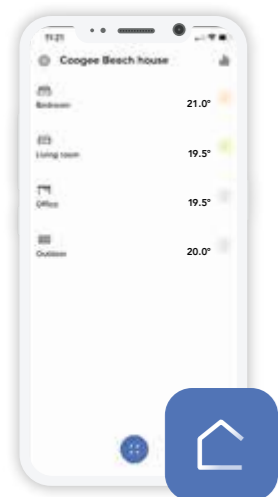

App HOME + CONTROL

INSTALLATION WITH TRADITIONAL WIRING

Install a traditional electrical system and enjoy SMART functions by connecting it to a home Wi-Fi network. Use the HOME + CONTROL App on a smart device to control lights, small appliances and shutters and more.

FUNCTIONS

- Lights
- Shutters
- Sockets
- Temperature control
- Scenario control
- Consumption display
- Load shedding control
- Planning programmed

CHOOSE HOW TO CONTROL IT

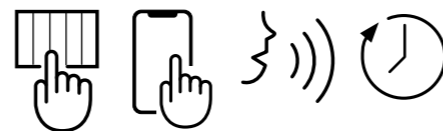

LIVING
now

HOME AUTOMATION SYSTEM

Living Now MyHOME

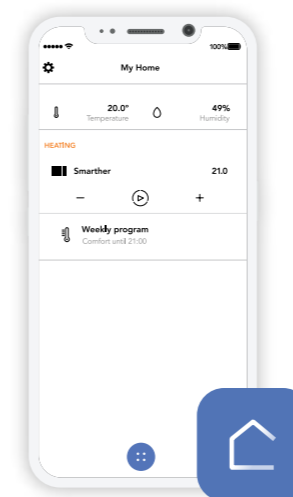

App HOME + CONTROL

INSTALLATION WITH BUS

Create a BUS integrated system manageable from the Home+Control App, using voice or the Touch Screen controls.

FUNCTIONS

- Lights
- Shutters
- Sockets
- Temperature control
- Scenario control
- Consumption display
- Load shedding control
- Burglar alarm
- Video door entry system
- Integration with other brand.

CHOOSE HOW TO CONTROL IT



SMART ELECTRICAL SYSTEM

Check in on your home just like you would for your emails or bank account. Enjoy the convenience of complete home control right at your finger tips.

App HOME + CONTROL

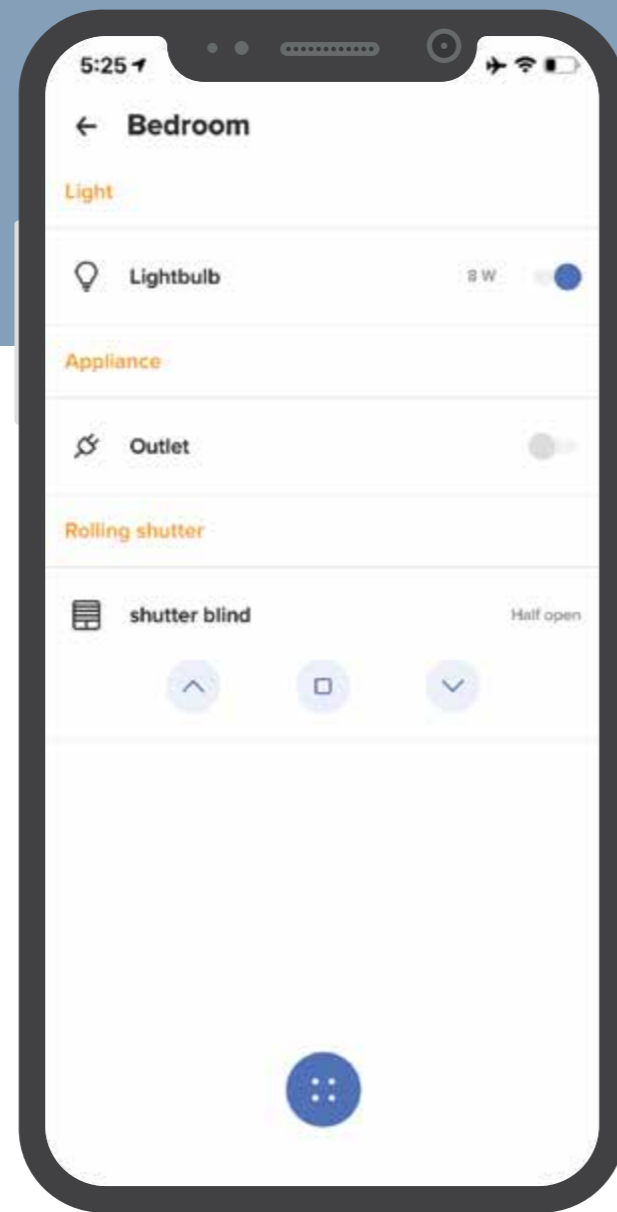

GENERAL CONTROL

With one single click, a general control will allow you to switch off lights and lower all the shutters when you leave home, or activate your favourite scenario.



CONTROL WITH SMARTPHONE

From your smartphone, you will be able to view and check the status of lights, shutters and connected power sockets from anywhere.

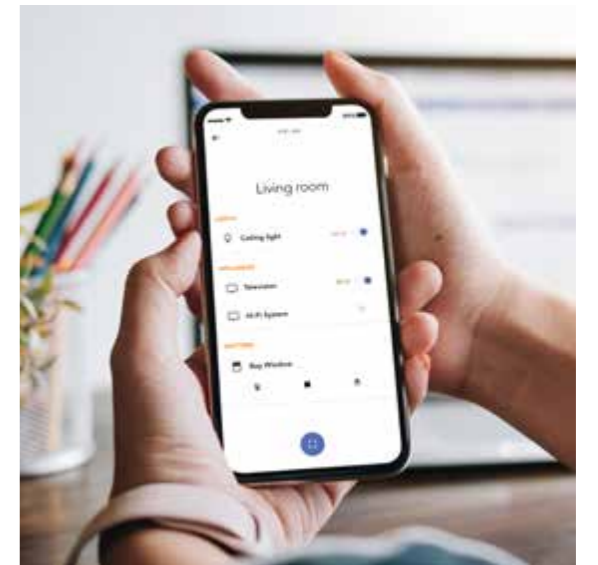

VOICE COMMAND

Control your system using your voice via your preferred digital assistant.

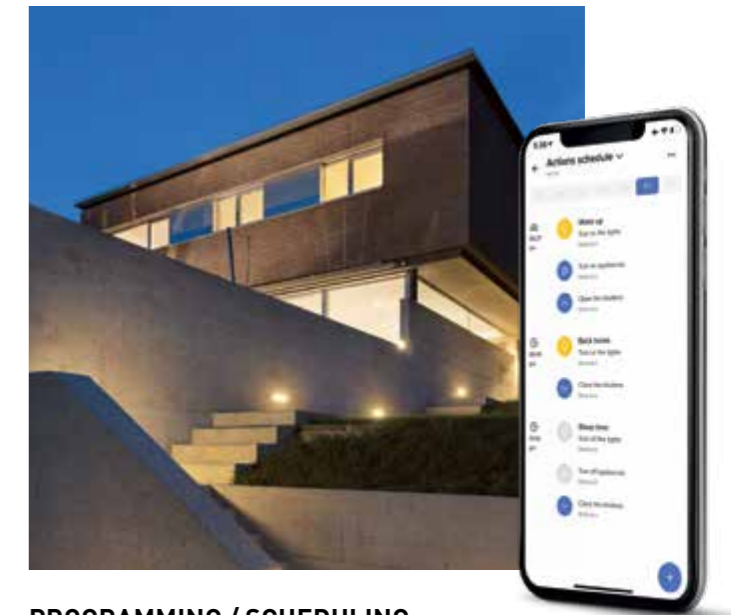

PROGRAMMING / SCHEDULING

Program the activation of lights, shutters and loads connected to sockets based on your needs. Appliances:

- automatically switch on the garden lights at sunset and switch them off at sunrise;
- switch on a selection of lights and activate shutters to give the impression you are home while away on holidays.

Smart electrical system

TEMPERATURE MANAGEMENT

Remotely check and manage the temperature inside your home using your smartphone via the connected thermostat Smarter with Netatmo.



LOAD SHEDDING TO AVOID BLACKOUTS

In overload conditions, the system automatically disconnects the least important load to avoid tripping circuit breakers (blackout).



ENERGY CONSUMPTION CONTROL

Use your smartphone to check electricity consumption of your appliances (daily, monthly and yearly).



LIGHTING AT THE DESIRED LEVEL

Adjust the light level for optimum personal comfort. You can do that from the connected Dimmer, the associated wireless controls and Smartphone, using the Home+Control App.



WIRELESS CONTROL

Add wireless controls (lights, shutters and sockets), or reposition them at any time depending on your needs.



ALARM NOTIFICATIONS

Receive warning notifications on your smartphone.

HOME + CONTROL

One single App, many connected advantages



Home+Control is the App that makes it simple to supervise the Living Now Smart system using iOS and Android mobile devices, inside and outside the home.

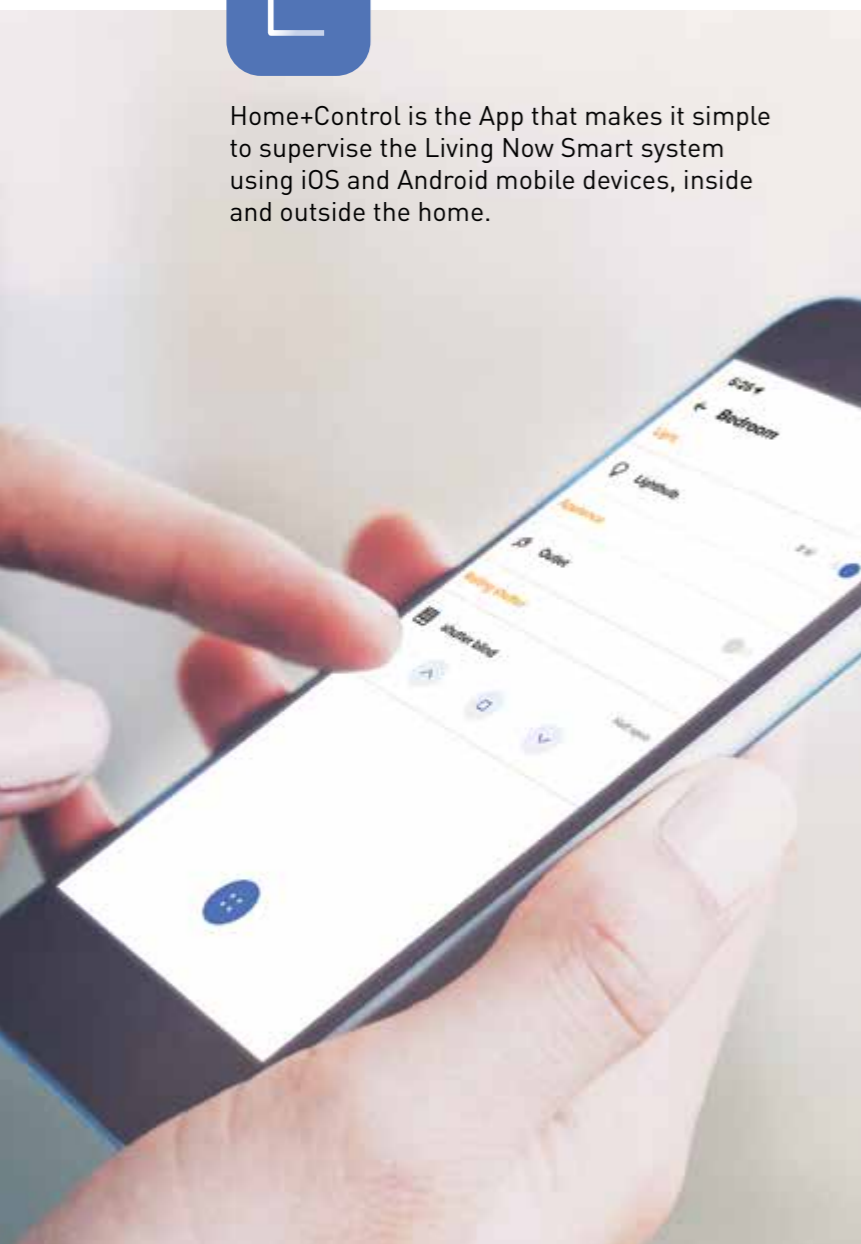

WHAT YOUR CUSTOMER CAN DO:

1. Activate and customise **8 scenarios** (4 preconfigured scenarios, coming in, going out, day, night and 4 scenarios customisable by the user);
2. **Display and check the status of lights, shutters, loads connected to sockets and the room temperature;**
3. **Use the Smarter timer thermostat** simply and intuitively;
4. **Check the total home consumptions.**
5. **Receive notifications** on the load and system status;
6. **Define the load priority** for black-out prevention.

HOME + CONTROL CONFIGURATION IS EASY, BOTH FOR YOU AND YOUR CUSTOMER.

Simply download the App from the Apple or Google store, and follow the guided instructions.

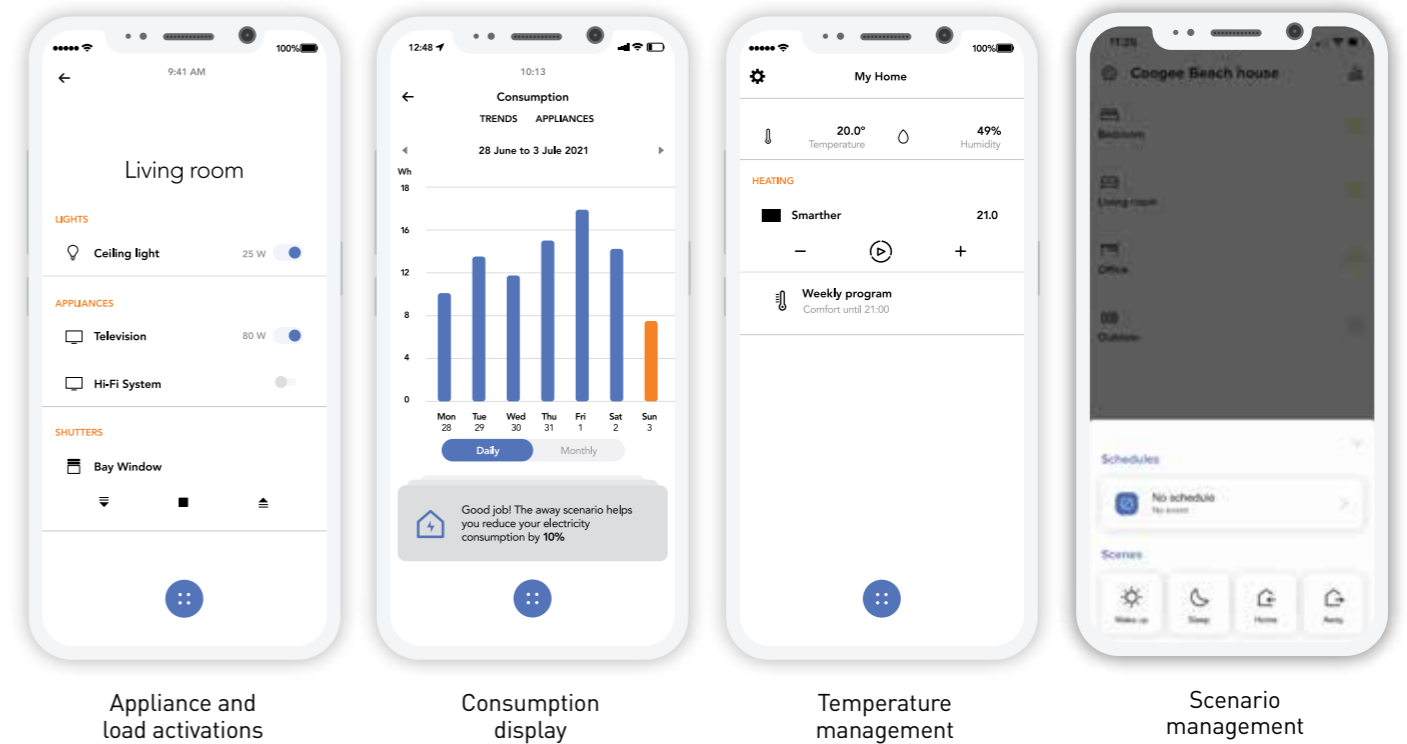

Appliance and load activations

Consumption display

Temperature management

Scenario management



YOUR CUSTOMERS CAN ALSO MANAGE THEIR HOME WITH THEIR VOICE

With Living Now with Netatmo, your customer will be able to control the system using Apple, Google and Amazon voice assistants. An extremely useful feature, also great for those with mobility problems.

"OK Google, set Kitchen light to 100%"

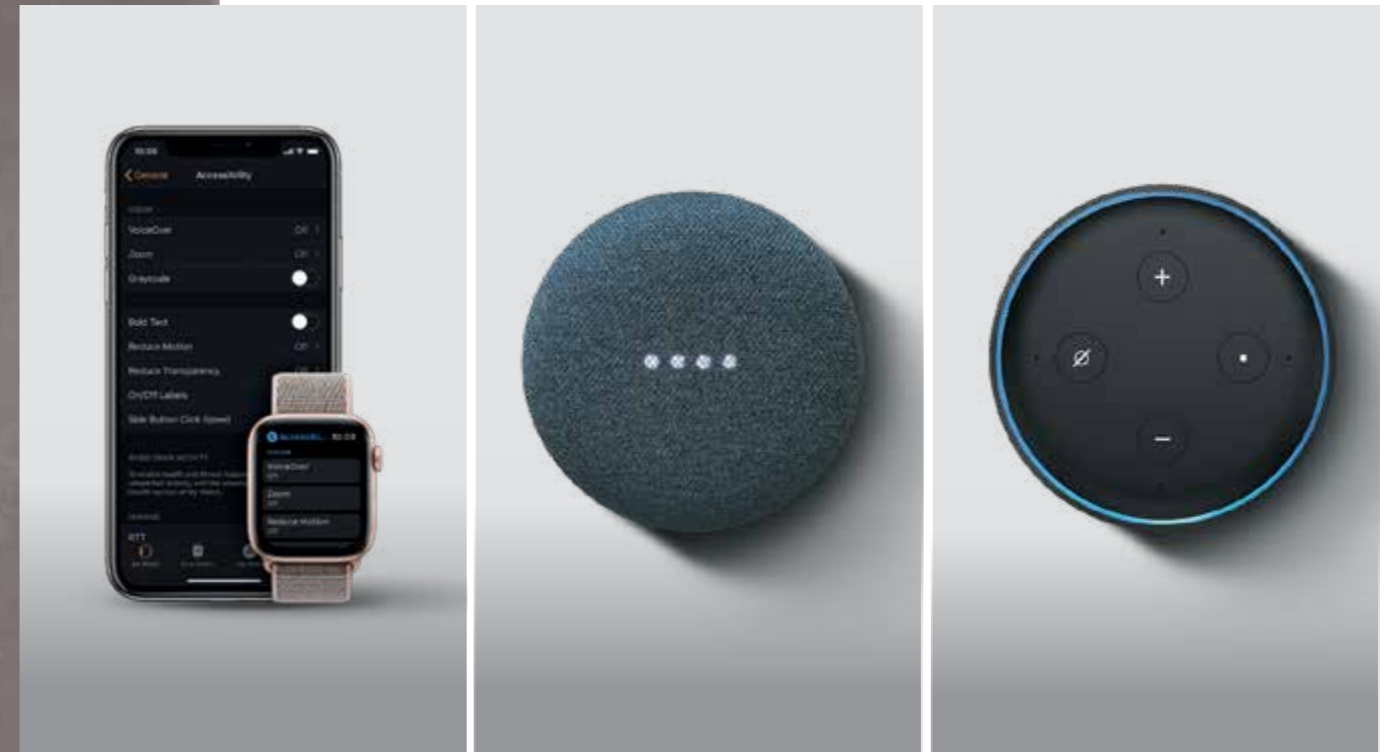

"SIRI, switch the bedroom light on",
 "OK Google, switch all the home lights off",
 "ALEXA, set temperature to 20 degrees".











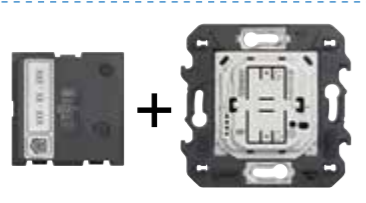









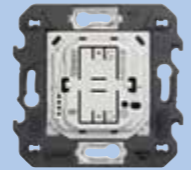

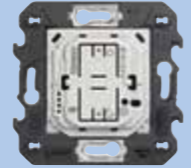
The Gateway connects the system to the Internet via the Home Wi-Fi network.

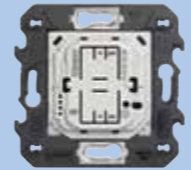
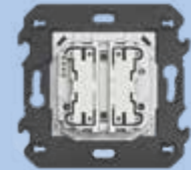
Note: HomePod, Google Home and Amazon Echo are available from Apple store, Google Store, Amazon, or from authorised retailers.

Note: HomeKit is a registered trade mark which is the property of Apple Inc. Google Home is a registered trade mark which is the property of Google LLC, Amazon Alexa is a registered trade mark which is the property of Amazon.com, Inc.

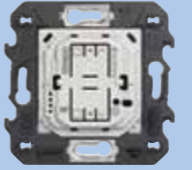
Smart electrical system: a simple, rational range of connected devices, both wired and wireless.

REMOTE CONNECTION	SCENARIOS	LIGHTS	SHUTTERS	ENERGY AND CONSUMPTION MANAGEMENT
<p>CONNECTED DEVICES (230V A.C.)</p>  <p>Cat no. K4500C Gateway with Home/Away wireless switch</p>  <p>Cat no. K4510C Gateway with Home/Away wireless switch</p> <p>Cat no. 412181 Gateway DIN</p>		 <p>Cat no. K4003C Connected two-way switch</p>  <p>Cat no. K4411C Connected switch/dimmer</p>  <p>Cat no. 412170 Connected DIN relay 16 A</p>  <p>Cat no. 574243 Connected light relay 1,3 A</p>	 <p>Cat no. K4027C Connected shutter control</p>  <p>Cat no. 067697 Connected micromodule for shutter</p>	 <p>Cat no. K4531C Connected module for socket -16 A</p>  <p>Cat no. 412015 Connected DIN meter</p>
<p>BATTERY OPERATED WIRELESS CONTROLS</p> 	 <p>Cat no. K4570CW Home/Away wireless switch</p>  <p>Cat no. K4570CWI Home/Away wireless switch</p>  <p>Cat no. K4575CW 4 scenarios control</p>  <p>Cat no. K4574CW Night&Day scenario control</p>  <p>Cat no. K4574CWI Night&Day scenario control</p>	 <p>Cat no. K4003CW Light control</p>  <p>Cat no. K4003DCW Double light control</p>  <p>Cat no. K4003CWI Light control</p>  <p>Cat no. 574252 Motion sensor</p>  <p>Cat no. 067694 Wireless module for mechanical switch</p>	 <p>Cat no. K4027CWI Shutter control</p>  <p>Cat no. K4027CW Shutter control</p>	<p>Connected thermostat Smarter</p> 

See catalogue for detailed descriptions, availability and full range of products.

INSTALLED JUST LIKE A TRADITIONAL ELECTRICAL SYSTEM

1. DEVICES ARE INSTALLED AND WIRED LIKE TRADITIONAL DEVICES

In lieu of a traditional device, install the connected device of the corresponding type: one for each control point. Remember that the device must always be powered; therefore, ensure that the phase and neutral cables are present. Once installed, the connected control is operational straight away; you will therefore be able to switch the connected light on without the need to do anything further.



EXAMPLE OF A MULTI-WAY SWITCHING LIGHT POINT

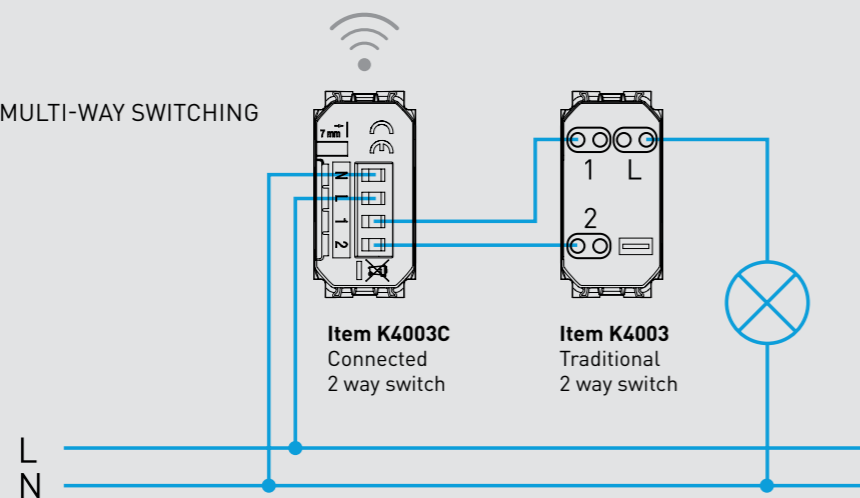

2. DEVICES CAN BE ASSOCIATED TO EACH OTHER BY SIMPLY PRESSING A PUSHBUTTON

A. Power the electrical system

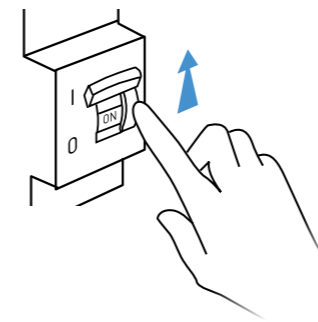

B. Simultaneously press both buttons (Home icons) on the wireless master switch for 5 seconds

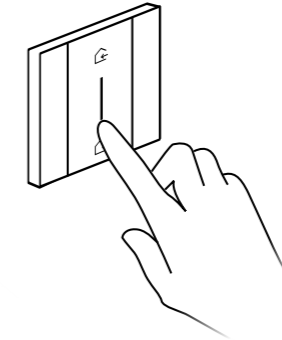

C. Devices are associated automatically. You can use the scenario control to activate the going out feature

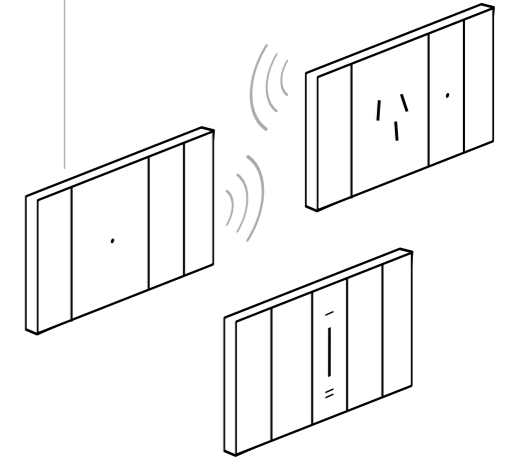

3. DOWNLOAD THE HOME+CONTROL APP AND FOLLOW THE SETUP ASSISTANT



App Home + Control



+ THE SYSTEM MAY BE EXPANDED WITH WIRELESS SWITCHES ASSOCIATED TO THE DEVICES BEING CONTROLLED

A. Simultaneously press both buttons (Home icons) on the wireless master switch for 5 seconds

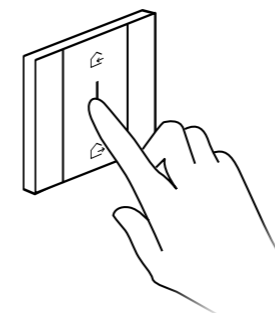

B. Place the devices to be associated in contact

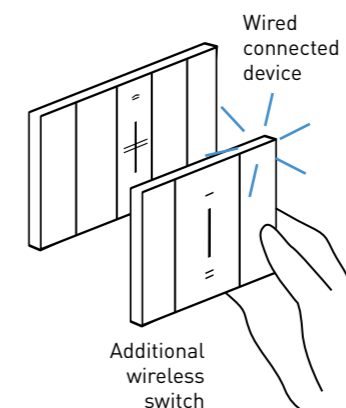

C. Install the wireless switch anywhere, based on the needs of your customer

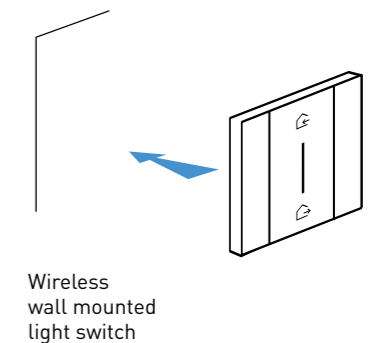



The **new** connected thermostat Smarter

WITH
Netatmo

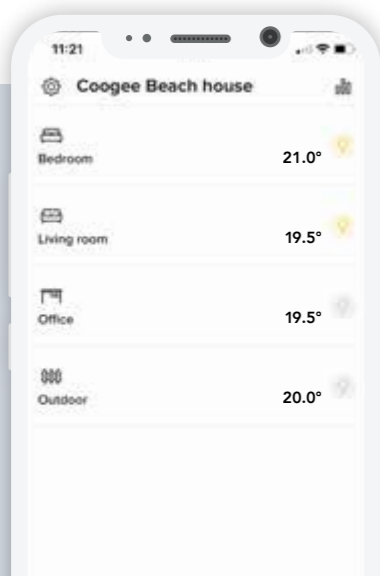

WITH THE APP IT'S ALL EASIER

- Remotely manage the thermostat simply and intuitively
- Create and modify weekly programs
- Manage the thermostat from several smartphones and different users
- Control several thermostats in the same home or different homes
- Manage the thermostat updates
- Combine the voice command with your favorite voice assistant (Amazon Alexa, Apple Home Kit or Google Home)

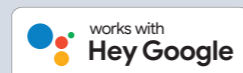
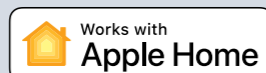

What can you do with the BTicino connected thermostat?



SETTING THE PROGRAMS

Using the Home + Control App, it is possible to set preset programs based on habits



AWAY

If you need to be away from home for a few days you can, via the APP, act remotely to adjust the thermostat (e.g. in antifrost mode) independent of the automatic programming.



BOOST

The Boost function can be used to activate the heating or cooling system for a limited time (30, 60 or 90 minutes), irrespective of the set program and the ambient temperature.



MONITORING CONSUMPTIONS

Using the Home + Control App, it is possible to easily manage and monitor consumptions.



MAXIMUM COMFORT IN EVERY ZONE

Using the same App, it is possible to manage several thermostats in the same home or in different homes.

The connected thermostat is simple and intuitive



Display the temperature and set it as desired



Display the set room temperature and humidity



Activate the Boost function

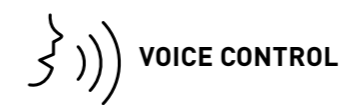

MyHOME INSTALL A BUS AUTOMATION SYSTEM

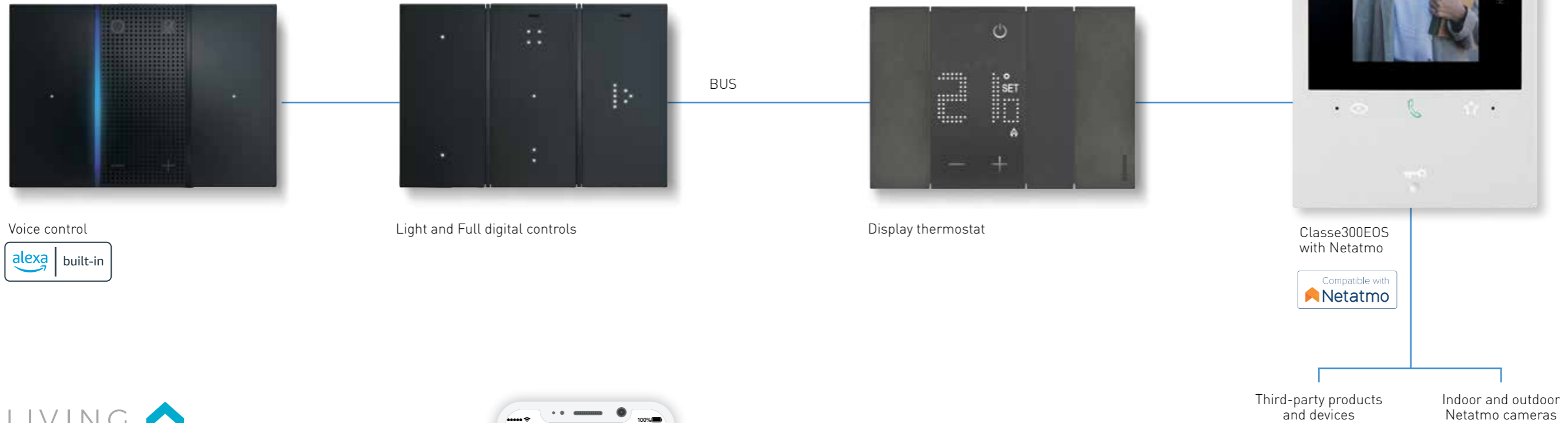

Voice control
alexa built-in

Light and Full digital controls

Display thermostat

Classe300EOS with Netatmo
Compatible with Netatmo

Third-party products and devices

Indoor and outdoor Netatmo cameras



The range of home automation devices is completed by two innovative Living Now digital controls offering innovative control of your system:

- voice control with built-in Amazon Alexa voice assistant
- Light and Full digital controls.

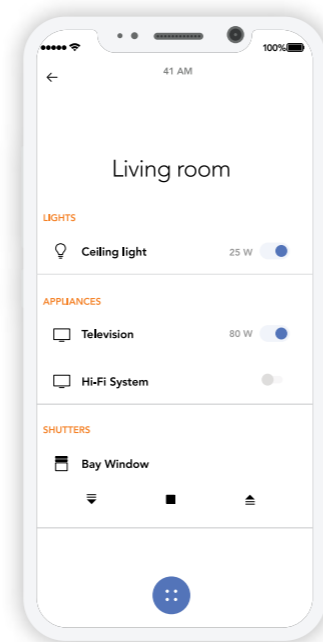

App Home+Control

EVERYTHING UNDER CONTROL

Thanks to MyHOME, end users can manage their homes in full freedom: using Living Now manual controls, Touch Screen devices and Smartphones with the Home+Control App.

MyHOME system can be managed by voice through the Voice Control Alexa built-in and also with the Amazon and Google vocal assistants

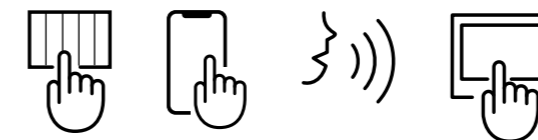

VOICE CONTROLS

Control the MyHOME functions with your voice

With BTicino devices

CLASSE 300EOS WITH NETATMO: THE FIRST VIDEO INTERNAL UNIT WITH BUILT-IN ALEXA

Enjoy the full Alexa experience interacting with all its functions, such as: Custom routines - Play Music - Smart Home - To set the clock alarms - Memos and video door entry functions. Also compatible with HOMEKIT.



VOICE CONTROL WITH BUILT-IN AMAZON ALEXA VOICE ASSISTANT

Innovative device without cover plate with built-in Amazon Alexa voice assistant for flush mounted installation. Ideal for installing in each room of the home a voice control for the management of MyHOME.



LIVING NOW

Or with Google and Amazon voice assistants

Thanks to the integration of MyHOME with the Google Home and Amazon Alexa voice assistants you can now control the lights and controlled sockets and, using the scenarios, the shutters, burglar alarm, ideal temperature and the music played by the system using your voice as well.

An important functionality which improves the comfort and usability MyHOME, especially by old people or long-stay patients who cannot interact with the manual controls.

As well as asking for information on the news, weather, times etc. you will be able to interact with the MyHOME system by using voice controls of the following type:

- "Ok Google, switch off all the lights"
- "Alexa, raise the living room shutters"
- "Alexa, welcome me home".

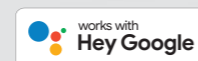

YOU ASK, ALEXA ANSWERS.
Use your voice to activate home automation functions in your home: lights, shutters, scenarios, favourite music, or ask for any other information.

Note: with the "Welcome me home" scenario, it is possible to activate lights and shutters and disable the burglar alarm.



Note: with the "Relax" scenario, it is possible to activate lights and shutters, set a comfort temperature and listen to the preferred music through the NUVO multi-room system.

A NEW WAY TO TOUCH HOME AUTOMATION

LIGHT CONTROLS AND FULL CONTROLS: A MULTISENSORIAL EXPERIENCE

- New touch controls without cover plate
- Customised icons and LEDs using the app Digital Controls
- Light and Full controls expandable to new functions



App Digital Controls

CREATE CUSTOMISABLE FUNCTIONS

The function associated to the control device and the corresponding icon can be changed at any moment, using the app Digital Controls.

FUNCTION MODIFICATION



From dimmer control



To shutter control

FUNCTION EXTENSION



From the control of one light



To the control of two lights



LIGHT CONTROL
To manage the lighting
(1 or 2 lights, group and general)

CHOOSE BETWEEN FULL AND LIGHT CONTROLS

Digital controls for every need.
Two versions, endless customisation to be adapted to any lifestyle.



FULL CONTROL
From 1 to 3 lights, dimmer, roller shutters, nuvo audio, load controls and scenarios.

EXTEND THE CONTROL

Expand the system by adding new control devices with a new frame. Without wiring.

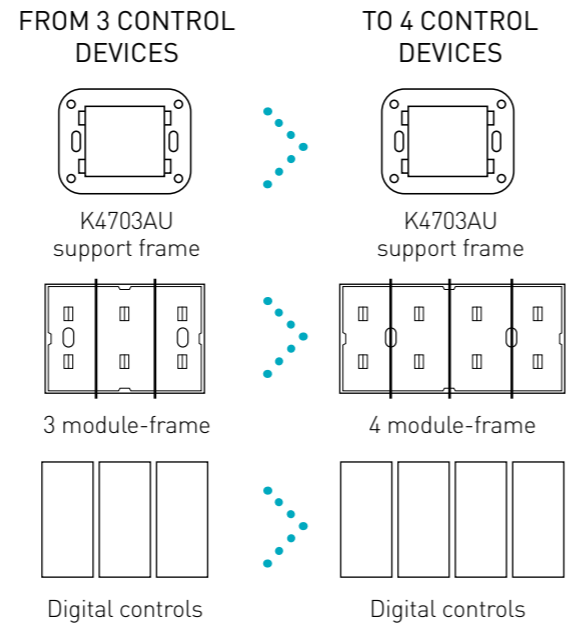

MOVE THE POSITION

With a simple operation, its possible to change the position of a control device while maintaining its function without wiring.



FROM THE LIVING ROOM

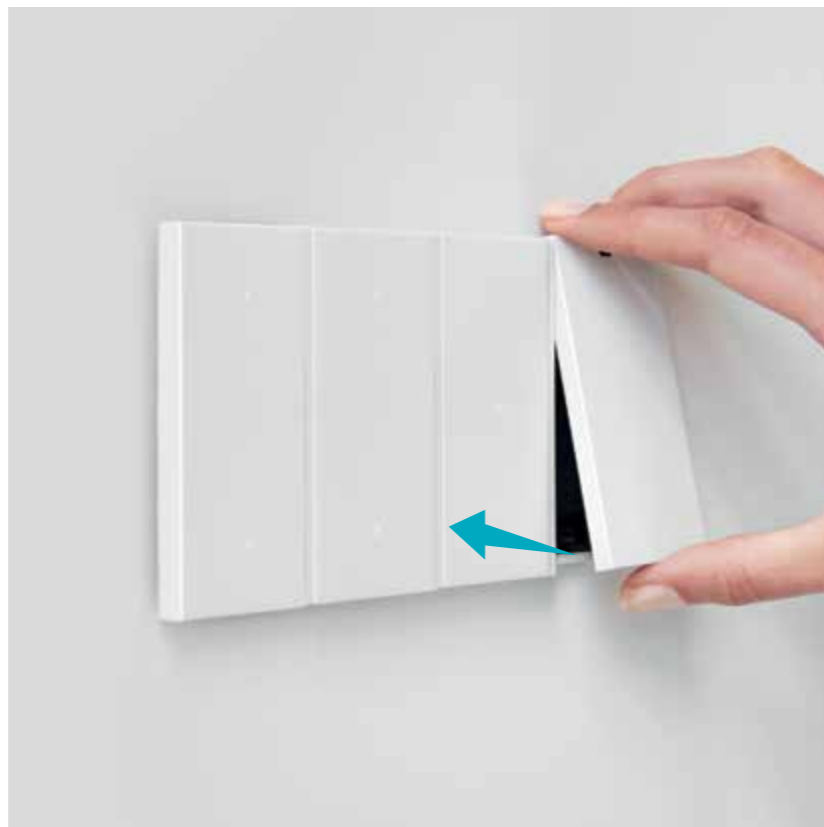
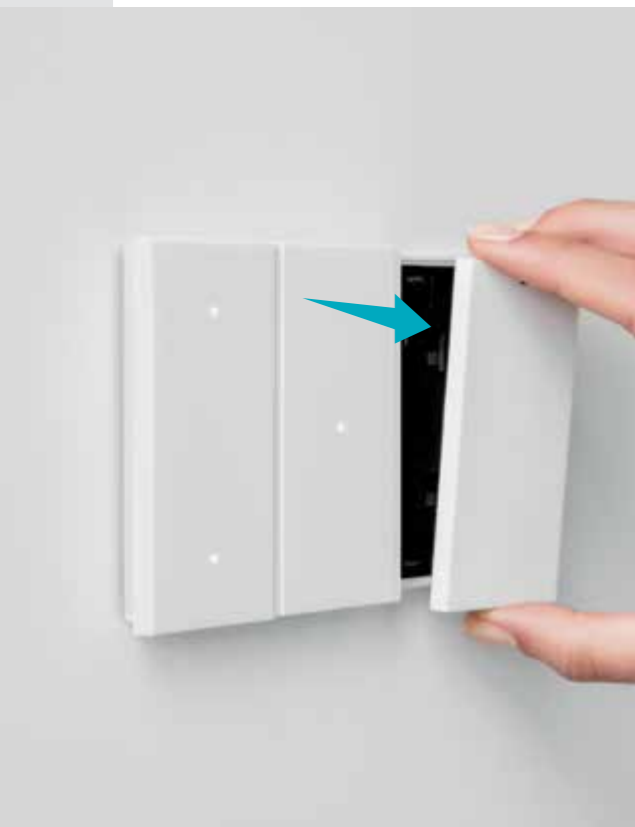

TO THE BEDROOM

INSTALLATION OF DIGITAL CONTROLS

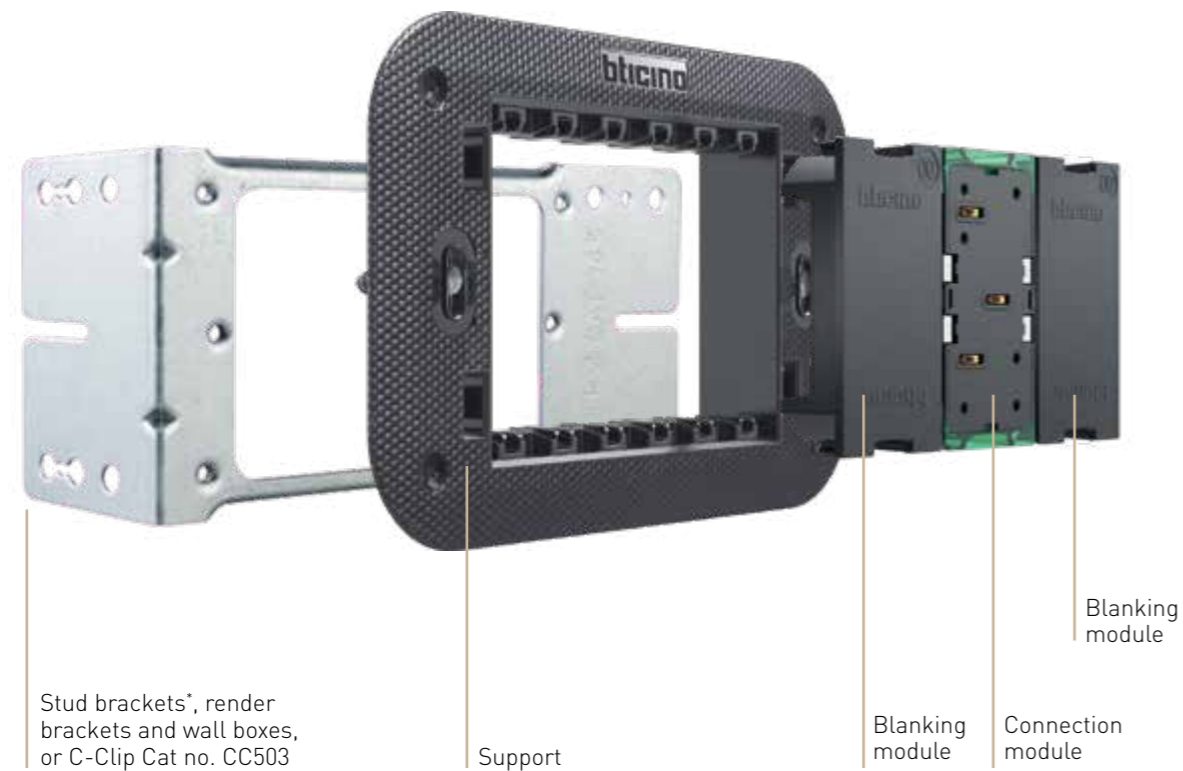

FUNCTIONAL ELEMENTS

INSTALLATION

With reference to the illustration, digital devices are installed using traditional mounting accessory and support, using an appropriate "frame" with 27 V d.c. control device power supply contacts.

The Module for connection to the BUS system is installed on the support frame Cat no. K4703AU which has been designed to fit 10mm thick minimum plasterboard walls.

This support frame is compatible with most of stud brackets, render brackets or wall boxes used on Australian and New Zealand markets. If a C-clip is required, only use Cat no. CC503.

* Stud bracket "opening window" should be minimum 74x55mm. To allow perfect fitting of K4703AU grids, installer will have to trim plasterboard around mounting holes



AESTHETIC ELEMENTS

INSTALLATION OF VOICE CONTROL

This operation is completed in a similar way as the installation of digital controls, but it requires the removal of the two vertical finishing elements from the frame.

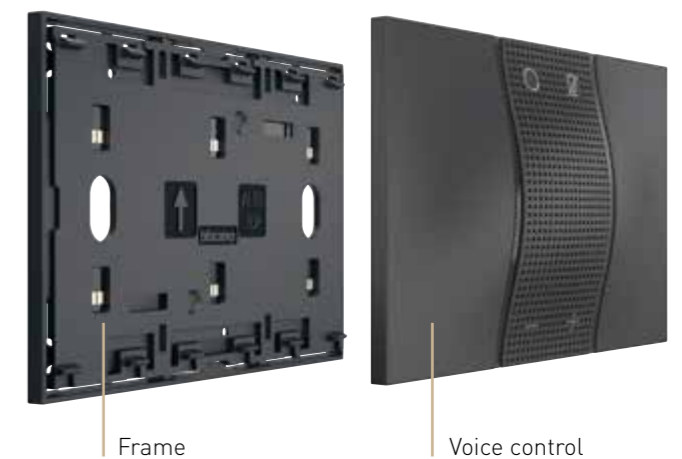

INSTALLATION PRINCIPLES

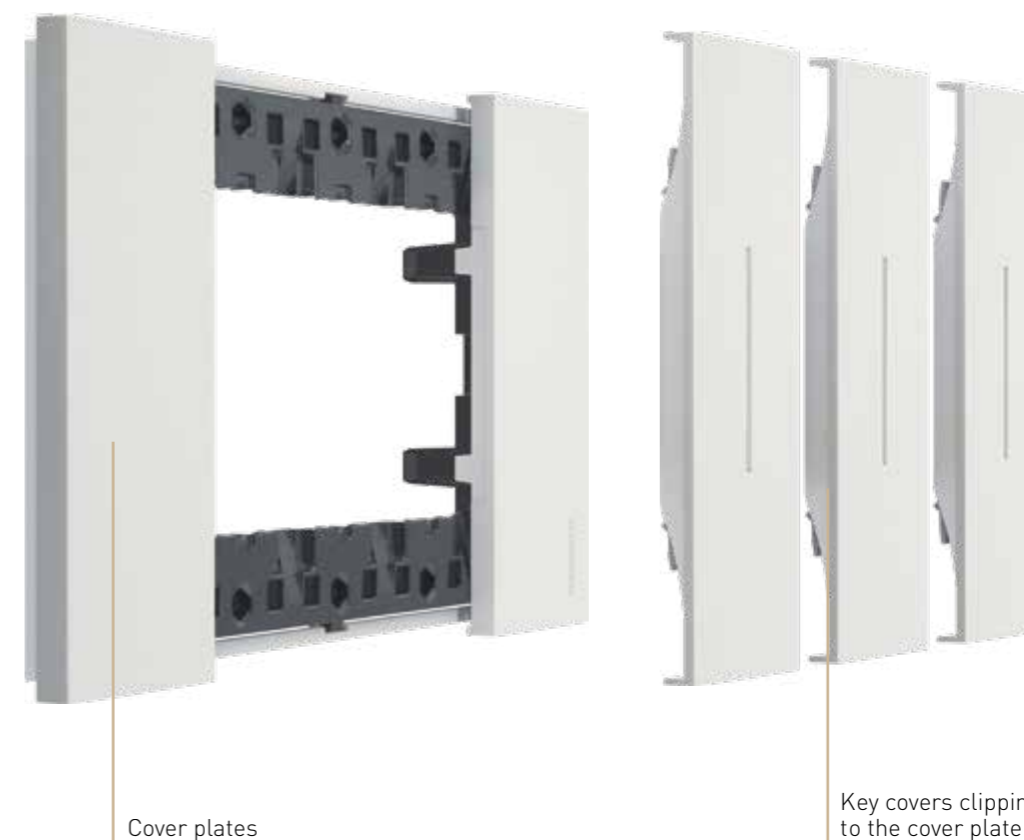
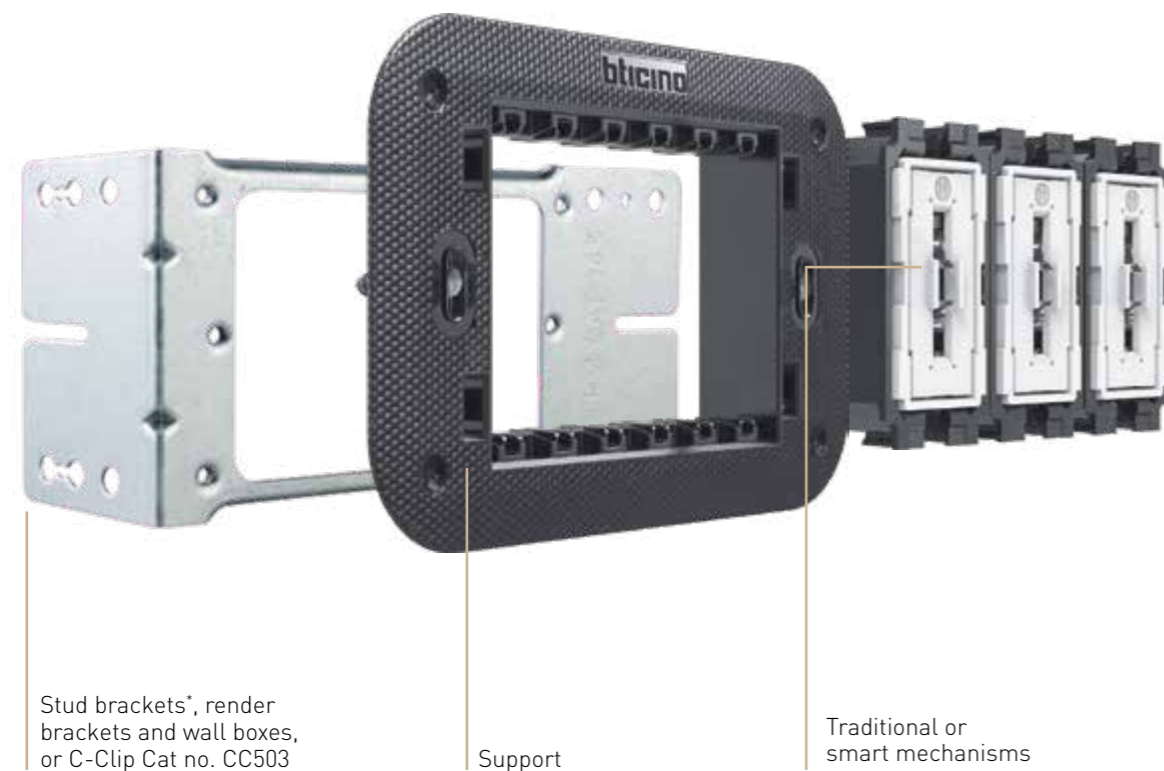

FUNCTIONAL ELEMENTS

AESTHETIC ELEMENTS

STANDARD INSTALLATION

In both cases of **traditional** and **connected devices**, installation is business as usual, with the following characteristics:

- Traditional wiring.
- 3 Module support frame (Cat no K4703AU), Single and Double powerpoints have been designed to fit 10mm thick minimum plasterboard walls: They are compatible with most of stud brackets, render brackets or wall boxes used on Australian and New Zealand markets. If a C-clip is required, only use Cat no. CC503.
- 4 and 6 Module support frames: use dedicated wall mounting boxes, refer to p.58.

SITE ACTIVITY SEQUENCE

- Install the system, fully working, but without aesthetic elements (cover plates and key covers)
- Protect the light point using the protective shell (supplied with the support)
- After completing all the works (including the painting of the walls), install the cover plates and the key covers

MORE ADVANTAGES

- When repainting the walls in the future, the customer will be able to easily remove the light point aesthetic components, cover plates and key covers, and just as easily replace them on completion of the works
- After a few years the customer decides to change light points?
It is possible to simply change the key covers, without touching the mechanisms

* Stud bracket "opening window" should be minimum 74x55mm. To allow perfect fitting of K4703AU grids, installer will have to trim plasterboard around mounting holes

SOLUTIONS FOR AN ALWAYS PERFECT INSTALLATION

FULL TOUCH CONTROL: ERGONOMICS

The entire surface is functional. It can be activated from the top, bottom or centre, ensuring exceptional ergonomics.



FULL TOUCH CONTROL: ELECTRO MECHANICS

1) tested with over 80,000 activations with the load connected; double than the standard requirements. This equals over 40 years of "normal" use.
2) 10AX 250 V, tested up to 700 A peak; also perfect for the new LED light bulbs, which generate significant peak current when switched on.

SELF CENTERING SYSTEM

This patented cover self-centering system ensures that the control covers are always aligned with the other components of the light point, even after extended use.



FLOATING FRAME

It's the flexible floating frame at the back of the cover plate that ensures that the light point perfectly adheres to any wall.

The floating frame gives the possibility of:

- 1) hiding wall defects;
- 2) hiding any irregularity in flush mounted boxes positioning;
- 3) hiding the external collars of plasterboard boxes.

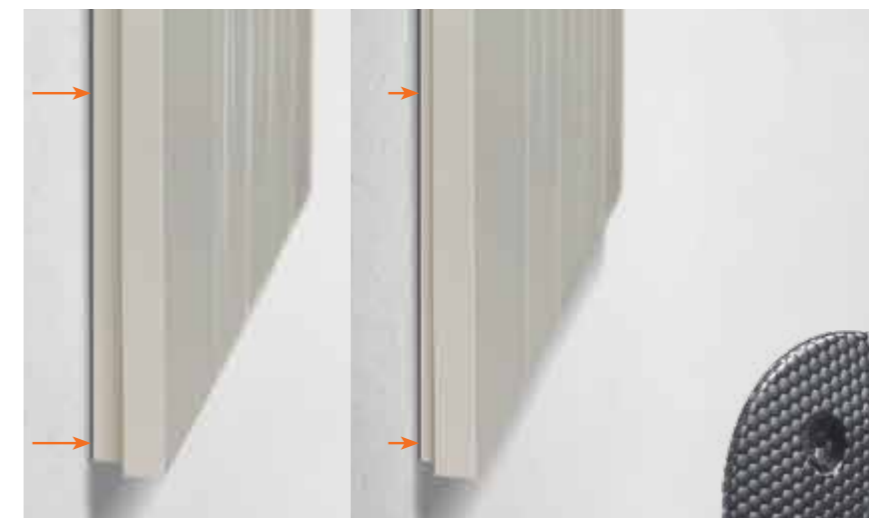

STRONGER SUPPORT

Reinforced frame, thanks to the new geometry and high performance materials.



BETTER PROTECTION

The support has a protective shell, which can be used to protect supports and mechanisms from possible damage during decorating activities, for example when painting the walls.



LVNSW1WE



LVNSW2BL



LVNSW3WE



LVN787ABL



LVN777AWE

Living Now



Cat. no.	Switches 10 AX - 250 V a.c. - Two-way
<input type="checkbox"/> LVNSW1WE <input checked="" type="checkbox"/> LVNSW1BL	Supplied with clip-in illumination LED accessory 1 gang White Black
<input type="checkbox"/> LVNSW2WE <input checked="" type="checkbox"/> LVNSW2BL	2 gang White Black
<input type="checkbox"/> LVNSW3WE <input checked="" type="checkbox"/> LVNSW3BL	3 gang White Black

Cat. no.	Powerpoints 10 A - 250 V a.c.
<input type="checkbox"/> LVN787AWE <input checked="" type="checkbox"/> LVN787ABL	Single powerpoint White Black
<input type="checkbox"/> LVN777AWE <input checked="" type="checkbox"/> LVN777ABL	Double powerpoint White Black
Data outlet Cat6	
<input type="checkbox"/> LVNDA1WE <input checked="" type="checkbox"/> LVNDA1BL	1 gang White Black
<input type="checkbox"/> LVNDA2WE <input checked="" type="checkbox"/> LVNDA2BL	2 gang White Black



Devices to be completed with appropriate cover as indicated below

Cat. no.	Switch, two-way switch, pushbutton, intermediate switch 10 AX - 250 V~
○ K4003	1P 10 AX, 250 V~ 2-way switch, screw and plates terminals, lightable - 1 module
○ K4004	1P 10 AX, 250 V~ 4-way switch, screw and plates terminals - 1 module
○ K4004L	1P 10 AX, 250 V~ LIT Intermediate switch, screw and plates terminals, with white LED for backlighting (the LED is not interchangeable) - 1 module
○ K4004LB	1P 10 AX, 250 V~ LIT 4-ways switch, screw and plates terminals, with blue LED for backlighting (the LED is not interchangeable) - 1 module

Cat. no.	Pushbutton 10 A - 250 V~
○ K4005	1P (NO) 10 A, 250 V~ pushbutton, screw and plates terminal, lightable - 1 module

Cat. no.	Covers
□ KW01 ■ KG01	1 module Lightable cover for item K4003, K4004, K4004L, K4004LB, K4005
□ KW01M2 ■ KG01M2	2 modules Lightable cover for item K4003, K4004, K4004L, K4004LB, K4005

□ White colour cover

■ Black colour cover

○ Neutral item (without cover)



Devices to be completed with appropriate cover as indicated below

Cat. no.	Dimmer
○ K4411	Universal dimmer Universal pushbutton dimmer - resistive/ inductive/ capacitive/fluorescent/compact/ dimmer LED. 100 to 240 V~ 50 ÷ 60 Hz - connection without neutral - 2 modules
○ K4410	Dimmer for ballast lamp Pushbutton dimmer for ballast lamp with 0-10V output. 100 to 240 V~ 50 to 60 Hz - 2 modules

Cat. no.	Cover
□ KW19 ■ KG19	1 module Cover for item K4411, K4410

DIMMER K4410 - LOAD COMPATIBILITY

		1-10 V		
240 V	Max	600 VA	600 VA	600 VA
	Min.	20 VA	20 VA	20 VA
100 V	Max	300 VA	300 VA	300 VA
	Min.	20 VA	20 VA	20 VA

DIMMER K4411 - LOAD COMPATIBILITY

		R	L	C/L		Dimmable	Dimmable LED
240 V	Max.	400 W	400 W	400 VA	200 VA	75 W or max. 10 lamps	75 W or max. 10 lamps
	Min.	3 W	3 W	3 VA	3 VA	3 W	3 W
100 V	Max.	200 W	200 W	200 VA	100 VA	37 W or max. 10 lamps	37 W or max. 10 lamps
	Min.	3 W	3 W	3 VA	3 VA	3 W	3 W

□ White colour cover



■ Black colour cover



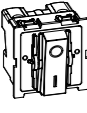

○ Neutral item (without cover)

Notes
- for the LEDs to use see the "Backlighting LEDs" section later on in the catalogue.
- for solutions requiring 2-module covers for the main controls, it will be necessary to install two "half-module blanking modules" (item K4949) at the sides of the control, see example on page 57.

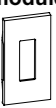

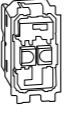

Devices to be completed with appropriate cover as indicated below



Cat. no.	Switches
<input type="checkbox"/> KW4002 <input checked="" type="checkbox"/> KG4002	 2P 16 AX, 250 V~, lightable switch - 1 module
<input type="checkbox"/> KW4302V32 <input checked="" type="checkbox"/> KG4302V32	 2P 32 A, 250 V~ switch, with white LED for backlighting (the LED is not interchangeable) - 1 module
Cover	
<input type="checkbox"/> KW02 <input checked="" type="checkbox"/> KG02	1 module  Cover for item KW4002 Cover for item KG4002
<input type="checkbox"/> KW02M2 <input type="checkbox"/> KG02M2	2 module  Cover for item KW4302V32 Cover for item KG4302V32

Cat. no.	Fan Controller
<input type="checkbox"/> KW4017 <input checked="" type="checkbox"/> KG4017	 Fan controller 240V~ 100W 50Hz - The cover of the selected colour is supplied in the same box as the fan controller - 2 module
<input type="checkbox"/> KW4441 <input checked="" type="checkbox"/> KG4441	Electronic thermostats  Electronic room thermostat - relay output with 1 contact in switching free of 5(2)A potential. - power supply 230 V~ - 2 modules
<input type="checkbox"/> K4027	Shutter/blind switches  1P 10 AX, 250 V~ changeover switch, double-key 1-0-2, not lightable - 1 module
<input type="checkbox"/> KW06 <input checked="" type="checkbox"/> KG06	Cover  Cover for item K4027 Cover for item K4027



Devices to be completed with appropriate cover as indicated below

Cat. no.	Australian standard sockets
<input type="checkbox"/> LVNM787A	Single socket  2 P+E 10 A , 250 V a.c. - autoswitched - 2 module
<input type="checkbox"/> LVNM777A	Double socket  2 P+E 10 A 250 V a.c. - autoswitched - supplied with grid

Cat. no.	Covers
<input type="checkbox"/> KW67 <input checked="" type="checkbox"/> KG67	Single socket  White Black
<input type="checkbox"/> KW69 <input checked="" type="checkbox"/> KG69	Double socket  White Black

Traditional electrical system
USB and wireless chargers



Devices to be completed with appropriate cover as indicated below

Cat. no.	USB charger
<input type="radio"/> K4191AC	USB charger with 2 type A and C ports for charging single electronic devices up to 15W or simultaneous charging of two devices. - 100-240 V 50-60 Hz DIRECT power supply Output voltage 5V - 1 module
<input type="radio"/> K4191CC	USB charger with 2 type C ports for charging single electronic devices up to 15W or simultaneous charging of two devices. - 100-240 V 50-60 Hz DIRECT power supply Output voltage 5V - 1 module
<input type="radio"/> K4192C	USB charger with 1 type C port for charging single electronic devices up to 20W. It allows the fast charge of portable devices (PC, tablets, smartphones) based on Power Delivery technology. - 100-240 V 50-60 Hz DIRECT power supply Output voltage 5 - 9 - 12V - 1 module
<input type="radio"/> K4285C2	5 Vdc type A USB charger for quick charge of one single electronic device up to 15 W or simultaneous charging of two devices - 110-230 V 50-60 Hz DIRECT power supply - 2 modules
<input type="radio"/> K4286C2	5 Vdc type C USB charger for quick charge of one single electronic device up to 15 W or simultaneous charging of two devices - 110-230 V 50-60 Hz DIRECT power supply - 2 modules
<input type="radio"/> K4287C2	5 Vdc type A and C USB charger for quick charge of single electronic devices up to 15 W or simultaneous charging of two devices - 110-230 V 50-60 Hz DIRECT power supply - 2 modules

Cat. no.	Cover for USB charger
<input type="checkbox"/> KW11C <input checked="" type="checkbox"/> KG11C	1 module Cover 1 module for item K4192C
<input type="checkbox"/> KW13C <input checked="" type="checkbox"/> KG13C	Cover 1 module for item K4191AC, K4191CC
<input type="checkbox"/> KW12C <input checked="" type="checkbox"/> KG12C	2 modules Cover for item K4285C2, K4286C2, K4287C2

White colour cover Black colour cover Neutral item (without cover)

Living Now
RJ connectors for data



Devices to be completed with appropriate cover as indicated below

Cat. no.	RJ45 connectors
<input type="checkbox"/> KW4279C6 <input checked="" type="checkbox"/> KG4279C6	Connectors for data/telephony transmission These connectors can be used for 4-pair signal transmission systems - 1 module Category: 6 UTP Type of connection: TOOLLESS IDC
<input type="checkbox"/> KW4279C6A <input checked="" type="checkbox"/> KG4279C6A	Category: 6A UTP Type of connection: TOOLLESS IDC
<input type="checkbox"/> KW07 <input checked="" type="checkbox"/> KG07	Cover for RJ45, RJ11 connectors and Keystone adapters 1 module Cover for all the RJ45 and RJ11 connectors

White colour cover Black colour cover Neutral item (without cover)

Living Now
TV sockets and A/V connectors







Devices to be completed with appropriate cover as indicated below





Item	TV socket 1 module
<input type="radio"/> K4202D	Direct coaxial socket for single-user aerial systems, including central remote powered systems and single-user central satellite systems with current and signal transfer for the selection of the channels - shielded connection clamps with captive screws - Diam. 9.5 mm - male connector - 1 module
<input type="radio"/> K4202F	Type F TV coaxial connector - impedance 75 Ω - screw hook - 1 module
<input type="radio"/> K4214D	Direct demixed coaxial socket for single-user aerial systems, also remote powered and shunting centralised and for single-user / shunting centralised satellite systems with current and signal transfer for the selection of the channels; Ø 9.5 mm male TV connector - type F SAT connector - 1 module
<input type="checkbox"/> KW08 <input checked="" type="checkbox"/> KG08	Cover for TV socket 1 module 1 module Cover for item K4202D and K4202F
<input type="checkbox"/> KW09 <input checked="" type="checkbox"/> KG09	Cover for item K4214D
<input type="radio"/> K4284P	Audio Connector A/V connector Pre-connected HDMI 1.4 connector - 1 module
<input type="checkbox"/> KW14 <input checked="" type="checkbox"/> KG14	Cover for audio and A/V connectors 1 module Cover for item K4284P

White colour cover Black colour cover Neutral item (without cover)



Devices to be completed with appropriate cover as indicated below





Item	Key card switches
○ K4549	 <p>Key card switch for the power supply inside the hotel room - slot light with built-in lamp - 30 second switch-off delay - power supply 230 V~. The completion of the light point requires two "half-module blanking modules" (item K4949) at the sides of the badge holder. To be installed with supports and cover plates with minimum size of 3 modules</p>
○ K4548	 <p>Key card switch for the power supply inside the hotel room - slot light with built-in lamp - 30 second switch-off delay - power supply 230 V~ - with RFID technology recognition. The completion of the light point requires two "half-module blanking modules" (item K4949) at the sides of the badge holder. To be installed with supports and cover plates with minimum size of 3 modules</p>
○ K4027H	Off-door controls  <p>1P 10 AX, 250 V~ changeover switch, double-key 1-0-2 for Hotel, LIT - 1 module (The LED is replaceable with item K4743V230RG)</p>
○ K4373	 <p>Lampholder with two built-in LEDs, green and red. Can be used as out of room visual signal with double notification: do not disturb and make up the room - The LEDs cannot be replaced - 127/ 230 V~ power supply - 1 module</p>





Item	Cover for functions for hotel
□ KW22M2 ■ KG22M2	2 modules  <p>Cover for item K4549 et K4548</p>
□ KW22 ■ KG22	3 modules  <p>Cover for item K4549 et K4548</p>
□ KW06H ■ KG06H	1 module  <p>Cover for item K4027H</p>
□ KW11H ■ KG11H	 <p>Cover for item K4373</p>

□ White colour cover ■ Black colour cover ○ Neutral item (without cover)

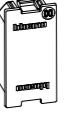

Devices to be completed with appropriate cover as indicated below

Cat. no.	LED for control and socket lighting
LN4743/230T	<p>LED for backlighting of the following "basic control devices": K4003 and K4005</p>  white LED - 230 V~ - night signal
LN4743/12T	 white LED - 12/24 V~ - night signal
H4743/230B	 blue LED - 230 V~ - night signal
H4743/12B	 blue LED - 12/24 V~ - night signal

Cat. no.	Blanking modules
K4950	 <p>Blanking module - 1 module</p>
K4949	Installation accessory  <p>1/2 module blanking module - does not require a cover</p>
□ KW00 ■ KG00	Covers for Blanking modules 1 module  <p>Cover for item K4950</p>
□ KW00M2 ■ KG00M2	2 modules  <p>Cover for item K4950</p>

EXAMPLES OF LED CONNECTION ON A SWITCH

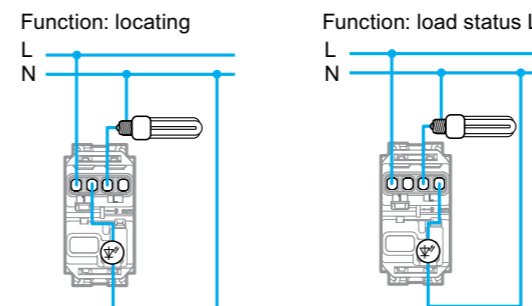

Control backlighting led connection

Note for the connection of 230 V.a.c. LEDs for the backlighting of control devices: when LEDs are fitted to help locate the control itself, it must be taken into account that energy saving and fluorescent lamps do not allow in series connection of the LED on the load. It is therefore necessary to also take a neutral conductor near the control, so that the LED may be connected directly between phase and neutral, and will always be on.

□ White colour cover ■ Black colour cover ○ Neutral item (without cover)

Living Now
support frames and mounting boxes

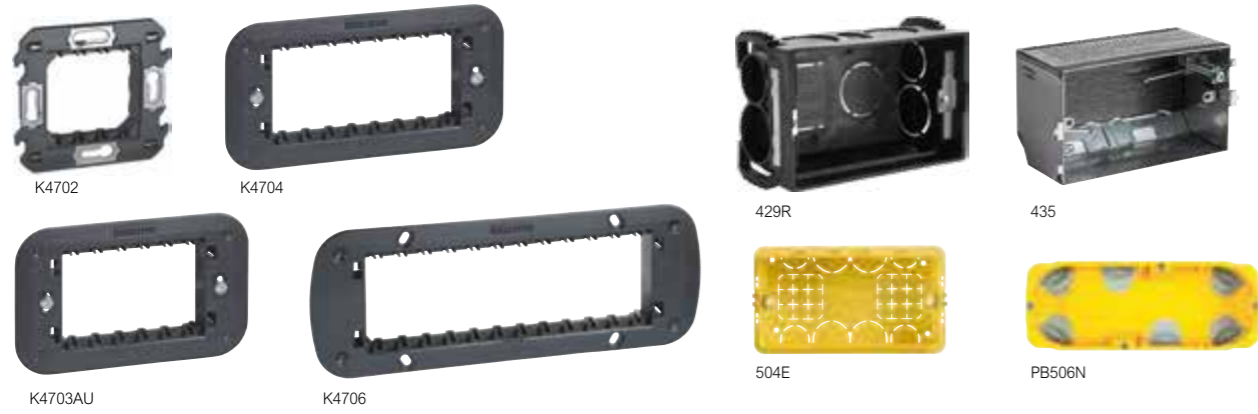

Cat. no.	Supports
K4702	2-module support frame supplied with protective shell
K4703AU	3-module support frame
K4704	4-module support frame supplied with protective shell
K4706	6-module support frame supplied with protective shell

Cat. no.	Mounting boxes
80151	For 2 module frame K4702 Flush-mount box
80051	Plasterboard box

Cat. no.	Mounting accessories
For 3 module frame K4703AU The 3 module frame K4703AU is compatible with most stud brackets, render brackets or wall boxes. If a C-clip is to be used, only Cat no CC503 is compatible	
CC503	C-clip
429R	Plastic wall box
435	Fire and acoustic rated box
For 4 module frame K4704	
504E	Flush-mount box
PB504N	Plasterboard box
For 6 module frame K4706	
506L	Flush-mount box
PB506N	Plasterboard box
For single powerpoints (LVN787A) and double powerpoints (LVN777A)	
CC503	C-clip

Living Now ^{WITH} Netatmo

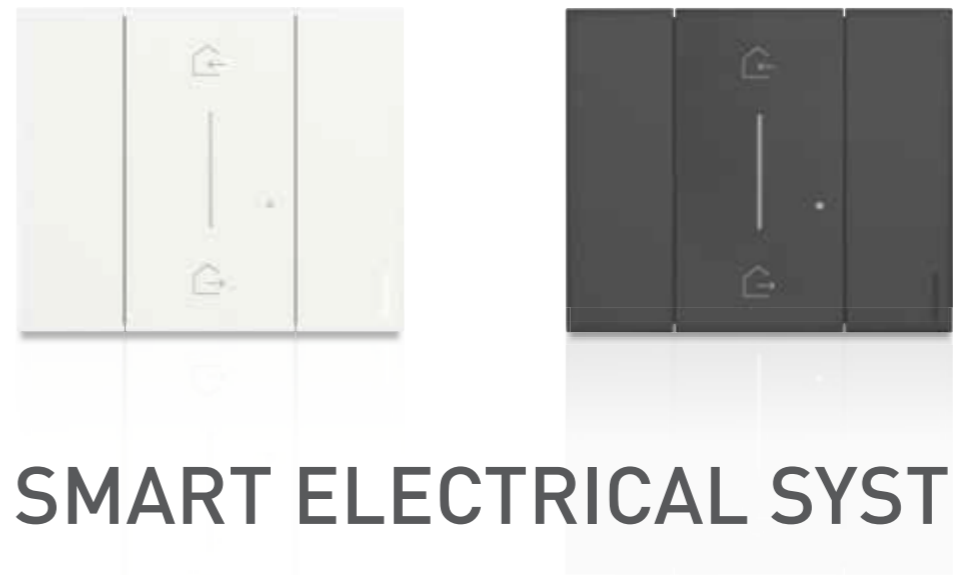

SMART ELECTRICAL SYSTEM



Installation sequence for a 3 gang switch

- White colour cover
- Black colour cover
- Neutral item (without cover)



Cat. no.	Gateway
○ K4500C	Gateway. This pack enables to create a connected installation in the home. It can be used to control lighting, roller shutters and electrical equipment plugged into connected sockets: - using your smartphone and the Home + Control app - using voice assistants - from the general control at the entrance to your home Supplied with the Home/Away wireless master switch required for the association procedure of all connected devices. Power supply 110-230 V~ - 2 modules
○ K4510C	Gateway as above. Supplied with the flush-mounted Home/Away wireless master switch 1 module required for the association procedure of all connected devices. Power supply 110-230 VA - 2 modules
○ 412181	Gateway as above for DIN switchboard. Supplied without wireless In&Out master scenario control item K4570CW. - 2.5 DIN modules.

Cat. no.	Cover required for the gateway
□ KW30M2 ■ KG30M2	2 modules Cover for item K4500C in combination with the relative colored cover item KW40M2, KG40M2, and for item K4510C in combination with the relative colored cover item KW40, KG40.

Cat. no.	Covers for the gateway scenario control
□ KW40 ■ KG40	1 module Cover for item K4570CW1 (scenario control in the gateway item K4510C)
□ KW40M2 ■ KG40M2	2 modules Cover for item K4570CW (scenario control in the gateway item K4500C)



Devices to be completed with appropriate cover as indicated below

Cat. no.	Connected switches and light relay
○ K4003C	Connected 2-ways switch. It allows to control lights locally or remotely. The connected 2ways switch has the same installation and usability of a traditional 2ways switch and it is compatible with all loads with max power 250 W. It s equipped with a blue LED light used always on for localization modality or on, when the light is on for the load status modality. It can be associated with "wireless light switches". Caution: Must be connected to the neutral. Power supply 110-230 V~ - 1 module
574243	Connected lighting micromodule. It allows to control lights locally or remotely. It is compatible with all loads with max power 300 W. It can be connected to one or more traditional push-button or associated with "wireless light switches". It is installed as a traditional rele in the box (behind the button) or in derivation boxes. Caution: Must be connected to the neutral. Power supply 110-230 V~

Cat. no.	Covers
□ KW01 ■ KG01	1 module Lightable covers for items K4003C
□ KW01M2 ■ KG01M2	2 modules Lightable covers for items K4003C

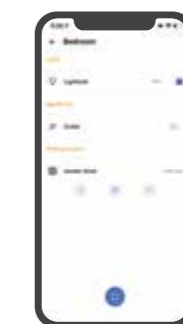

HOME + CONTROL

Note: for the use of the connected devices, the gateway, item **K4500C** or **412181** must be installed as part of the system.

If the gateway is connected to the internet through the Wi-Fi network, it will be possible to manage the system from the home using the specific **HOME + CONTROL** App

Three-way switching with connected two-way switch, item K4003C, installed instead of a traditional two-way switch

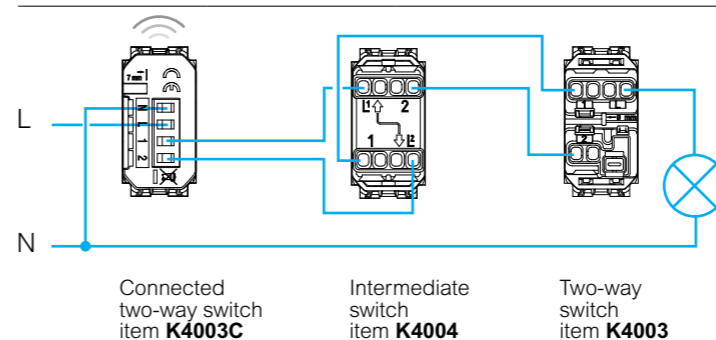

Three-point lighting control with pushbuttons and connected lighting micromodule, item 574243, installed instead of a traditional relay

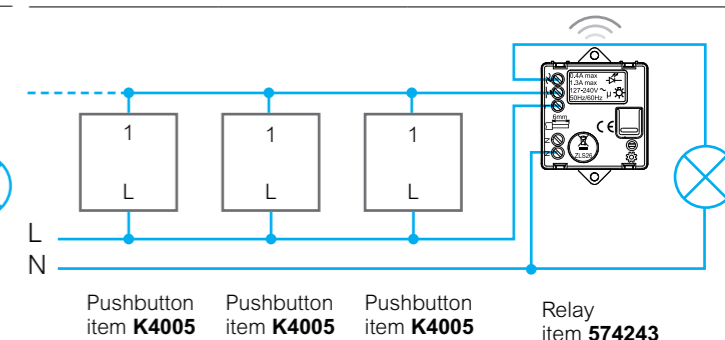



□ White colour cover

■ Black colour cover

○ Neutral item (without cover)

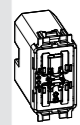

Devices to be completed with appropriate cover as indicated below

Cat. no.	Connected devices for shutters
○ K4027C	 <p>Connected rolling shutter switch - It allows the control of a shutter locally or remotely. Compatible with all standard rolling shutter motors (with a mechanical or electromechanical stop and max power 500 VA) controlled by a wired shutter switch (switching of the same motor power supply). Not compatible with motors for radio-controlled or pulse-controlled roller shutters. It can be associated with one or more wireless commands. Caution: Must be connected to the neutral. Power supply 110-230 V~ - 1 module</p>
○ K4027CM2	 <p>As K4027C - 2 modules</p>
○ 067697	 <p>Connected micromodule for shutters. Associated to one or more shutter wireless controls, it controls a shutter locally or remotely. Compatible with all standard shutter motors (with mechanical or electronic limit switch and maximum power 500 VA), controlled by a wired shutter changeover switch (changeover with the same power supply as the motor). Not compatible with radio controlled or pulse controlled shutter motors. It can be installed in the existing shutter box with no need of masonry works. Power supply 110-230 V~</p>

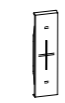
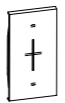
Cat. no.	Covers
<input type="checkbox"/> KW32 <input checked="" type="checkbox"/> KG32	1 module  <p>Cover for item K4027C</p>
<input type="checkbox"/> KW32M2 <input checked="" type="checkbox"/> KG32M2	2 modules  <p>Cover for items K4027C and K4027CM2</p>

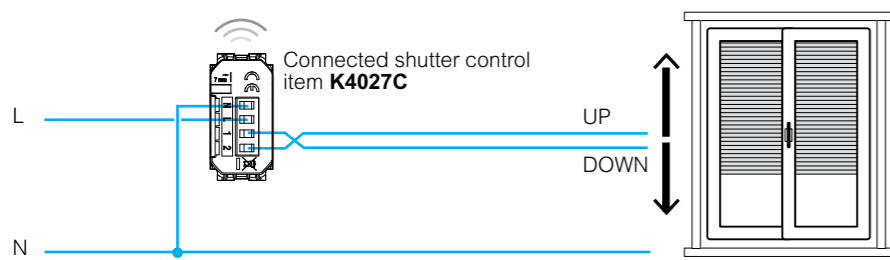

For correct operation, connect also the neutral conductor to the connected devices.

Note: for the use of the connected devices, the gateway, item **K4500C** or **412181** must be installed as part of the system.

If the gateway is connected to the internet through the Wi-Fi network, it will be possible to manage the system from the home using the specific **HOME + CONTROL** App

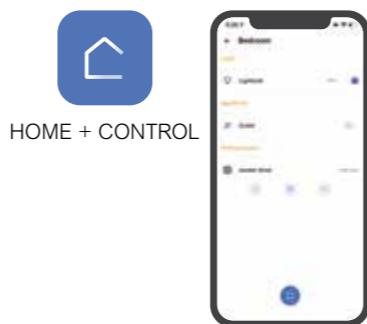



White colour cover Black colour cover

Neutral item (without cover)

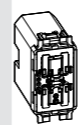

Devices to be completed with appropriate cover as indicated below

Cat. no.	Connected Dimmer/Switch
○ K4411C	 <p>Universal dimmer Dimmer/switch. It allows to control lights locally or remotely, with the dimmer functionality that can be activated from APP Home+Control. It has the same installation and usability of a traditional switch and it is compatible with all loads (LED, halogen) with max power 150 W at 230 V (or 75 W at 110 V). It s equipped with a blue LED light used for localization modality or load status modality, configurable by APP. It can be connected to one or more traditional push-button or associated with "wireless light switches". Caution: Must be connected to the neutral. Power supply 110-230 V~ - 1 module</p>

Cat. no.	Covers
<input type="checkbox"/> KW01 <input checked="" type="checkbox"/> KG01	1 module  <p>Cover for item K4411C</p>

Note: for the use of the connected devices, the gateway, item **K4500C** or **K4510C** must be installed as part of the system.

If the gateway is connected to the internet through the Wi-Fi network, it will be possible to manage the system from the home using the specific **HOME + CONTROL** App

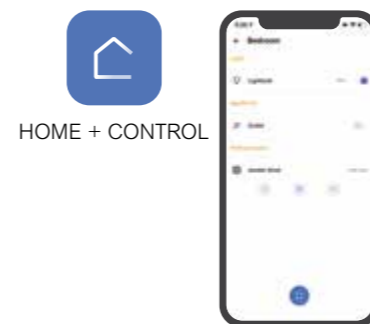

White colour cover Black colour cover



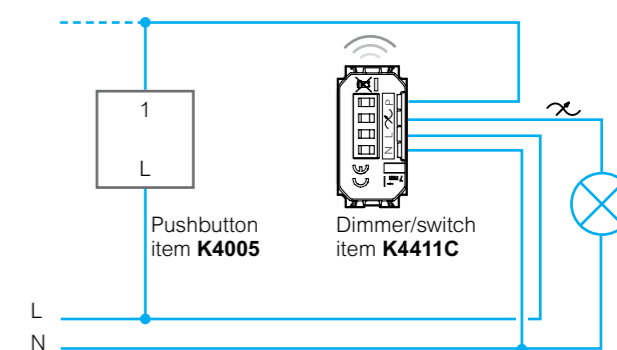

Neutral item (without cover)



Dimmer/switch item K4411C with remote pushbuttons

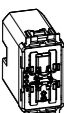

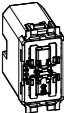

Devices to be completed with appropriate cover as indicated below

Cat. no.	Wireless controls for light
○ K4003CWI	 <p>Wireless light switch. It allows the ON / OFF and dimming control of one or more connected devices for the lighting control. It can be installed in any flush-mounted box without any wiring. The battery can be replaced without removing it from the supporting frame. Integrated LED for low battery indication. Powered by battery 3V type CR2032 (supplied) with an autonomy of 8 years - 1 module</p>
○ K4003CW	 <p>Wireless light switch. It allows the ON / OFF and dimming control of one or more connected devices for the lighting control. Surface installation with repositionable stickers (supplied) or onto a flush mounting box. Integrated LED for low battery indication. Powered by battery 3V type CR2032 (supplied) with an autonomy of 8 years - 2 modules</p>
○ K4003DCW	 <p>Wireless light switch. It is equipped with two buttons to control two different connected devices for lights. Each single button can be associated with one or more devices. Surface installation with repositionable stickers (supplied) or onto a flush mounting box. Integrated LED for low battery indication. Powered by battery 3V type CR2032 (supplied) with an autonomy of 8 years - 2 modules</p>
○ 067694	 <p>Wireless module for mechanical switch. It allows to change a two-way switch or a traditional pushbutton into a wireless light control for ON/OFF control of one or more devices connected for light control. The small size allows the installation in the flush mounted box. CR2032 type 3V power battery with 8 year expected life supplied (as standard).</p>

Cat. no.	Wireless controls for shutter
○ K4027CWI	 <p>Rolling shutter wireless switch - It allows the control of one or more connected rolling shutter switches. It can be installed in any flush-mounted box without any wiring. The battery can be replaced without removing it from the supporting frame. Integrated LED for low battery indication. Powered by battery 3V type CR2032 (supplied) with an autonomy of 8 years - 1 module</p>
○ K4027CW	 <p>Rolling shutter wireless switch - It allows the control of one or more connected rolling shutter switches. Surface installation with repositionable stickers (supplied) or onto a flush mounting box. Integrated LED for low battery indication. Powered by battery 3V type CR2032 (supplied) with an autonomy of 8 years - 2 modules</p>

Cat. no.	Cover
□ KW01 ■ KG01	 <p>1 module Cover for item K4003CWI</p>
□ KW33 ■ KG33	 <p>Cover for item K4003CW</p>
□ KW32 ■ KG32	 <p>Cover for item K4027CWI</p>
□ KW42M2 ■ KG42M2	 <p>2 modules Cover for item K4003CW</p>
□ KW36M2 ■ KG36M2	 <p>Cover for item K4003DCW</p>
□ KW43M2 ■ KG43M2	 <p>Cover for item K4027CW</p>



Cat. no.	Motion sensor wireless
○ 574252	 <p>It controls one or more devices connected for light control. Infrared detection with angle of 140°. Distance of the adjustable sensor from 2 to 8 m. Switch off delay with 1 to 30 min adjustable delay time and 1 to 1000 lux brightness threshold. Test possible with a 5 sec. delay. Recommended assembly height: 2.5 m. Optimum distance between 2 detectors: 6 m. For indoor and outdoor use (IP44). Supplied with 2 1.5V AA batteries for power supply.</p>

Note: for the use of the connected devices, the gateway, item **K4500C** or **412181** must be installed as part of the system.

If the gateway is connected to the internet through the Wi-Fi network, it will be possible to manage the system from the home using the specific **HOME + CONTROL** App



Devices to be completed with appropriate cover as indicated below

Cat. no.	Connected devices for energy management
○ K4531C	 <p>Connected socket module - wiring to a power outlet, allows to remotely control appliances and check the consumption (instantaneous, daily, monthly). It is also possible to receive notifications in case of anomalous consumption. The connected socket module is compatible with any device electric and large appliances up to 16 A 3680 W max. (protected against overloads). It is equipped with a LED light lit in blue when it is on. This option can be enabled or disabled in the "Home+Control" app. It can be associated with "wireless light switches". Power supply 110-230 V~ - 1 module</p>
○ 412015	 <p>Connected DIN meter. It allows to measure the energy consumption of the house electric installation (instantaneous, daily, monthly). It is also possible to receive notifications in case of exceeded the maximum power provided by your contract to avoid possible black-out. A toroid is provided to read the current. Power supply 110-230 V~ - 1 DIN module</p>

Cat. no.	Cover
□ KW31 ■ KG31	 <p>1 module Cover for item K4531C</p>



Living Now with Netatmo smart electrical system - MODULAR VERSION





wireless controls for scenarios management

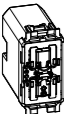

eliot



Devices to be completed with appropriate cover as indicated below

Cat. no.	Wireless Home/Away scenario controls
○ K4570CWI	 <p>Home / Away wireless switch. It is equipped with 2 buttons for activating Home / Away scenarios. Scenarios can be customized by the Home + Control app. It can be installed in any flush-mounted box without any wiring. The battery can be replaced without removing it from the supporting frame. Integrated LED for low battery indication. Powered by battery 3V type CR2032 (supplied) with an autonomy of 8 years - 1 module</p>
○ K4570CW	 <p>Home / Away wireless switch. It is equipped with 2 buttons for activating Home / Away scenarios. Scenarios can be customized by the Home + Control app. Surface installation with repositionable stickers (supplied) or onto a flush mounting box. Integrated LED for low battery indication. Powered by battery 3V type CR2032 (supplied) with an autonomy of 8 years - 2 modules</p>

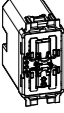
Cat. no.	Covers
<input type="checkbox"/> KW40 <input checked="" type="checkbox"/> KG40	1 module  Cover for item K4570CWI  Cover for item K4574CWI
<input type="checkbox"/> KW41 <input checked="" type="checkbox"/> KG41	2 modules  Cover for item K4570CW  Cover for item K4574CW
<input type="checkbox"/> KW37M2 <input checked="" type="checkbox"/> KG37M2	 Cover for item K4575CW

Cat. no.	Wireless Wake Up / Sleep scenario controls
○ K4574CWI	 <p>It is equipped with 2 buttons for activating Wake Up / Sleep scenarios. Scenarios can be customized by the Home + Control app. It can be installed in any flush-mounted box without any wiring. The battery can be replaced without removing it from the supporting frame. Integrated LED for low battery indication. Powered by battery 3V type CR2032 (supplied) with an autonomy of 8 years - 1 module</p>
○ K4574CW	 <p>It is equipped with 2 buttons for activating Wake Up / Sleep scenarios. Scenarios can be customized by the Home + Control app. Surface installation with repositionable stickers (supplied) or onto a flush mounting box. Integrated LED for low battery indication. Powered by battery 3V type CR2032 (supplied) with an autonomy of 8 years - 2 modules</p>

Cat. no.	Wireless 4 scenarios control
○ K4575CW	 <p>It's equipped with 4 buttons for activating of scenarios 1,2,3 and 4. Scenarios can be customized by the Home+ Control app. Surface installation with repositionable stickers (supplied) or onto a flushmounting box. Integrated LED for low battery indication. Powered by battery 3V type CR2032 (supplied) with an autonomy of 8 years - 2 modules.</p>

White colour cover Black colour cover ○ Neutral item (without cover)

Living Now



MyHOME





Classe 300EOS with Netatmo

344842 i2 wires/Wi-Fi handsfree connected video internal unit with built-in Amazon Alexa voice assistant, 5" vertical touch screen LCD display and video door entry answering machine. It has a physical key for door lock release and capacitive keys for the control of the main video door entry functions: handsfree communication, entrance panel activation / camera scrolling and Favourite key (can be configured to activate the quick actions most frequently used – e.g. additional door locks, staircase light control, intercom). There are notification LEDs for: Wi-Fi network connection status, info / notifications and call exclusion. It is possible to easily interact with the built-in Alexa voice assistant, either using the dedicated capacitive keys or with your voice, and activate several functions, such as the video door entry functions, Smart Home, scenarios, reminders etc. Using the touch display, it is possible to access the notification list, as well as your favourite door entry, security and Smart Home controls (if any). The device must be configured by physically connecting the configurators or using the menu, which will give better possibilities of customisation of associated functions and texts. Thanks to the Wi-Fi connection, you can associate the video internal unit to the Home + Security App (available for Android and iOS). The App allows to use the main video internal unit functions (receiving calls, door lock release, display of the event timeline and activation of the entrance panel/camera cycling). Through the Home + Security App, it is also possible to manage the products of the Netatmo security range (outdoor and indoor cameras, door and window sensors, indoor siren and smoke detector). This allows you to quickly and easily create a Smart security system. The device also allows to create and manage Smart Home functions using the wired SCS BUS solution, without the need for adding dedicated webserver. Wall mounted installation using the supplied bracket Possibility of Wi-Fi connection or using RJ45 ethernet

344844 Ethernet Accessory
Accessory cable for wired connection of Classe 300EOS with Netatmo video internal unit via RJ45 Ethernet cable. To be purchased separately.

346020 Power supply for Classe300EOS with Netatmo
Additional power supply to be used to supply entrance panels and internal units locally. 2 DIN modular enclosure. Power supply 230 Vac at 50-60 Hz. The output provides 27 Vdc continuous low voltage, with maximum current of 600 mA and it is protected on the PRI side (with fuse) against overload and short circuit. It is a SELV double insulation safety device.

MYHOMESERVER1 Control server using the app
Server to associate devices during the system starting-up and for the local and remote management of the functions by the user with the specific Home+Control application for Android and iOS smartphones or tablets.

Note: For the details of the products managed by MyHome_Up and the compatible products, see the corresponding guide.

HOMETOUCH - Touch screen 7"

067259 HOMETOUCH - Touch Screen 7" for the management of all MyHOME functions, that can be integrated with the video door entry system and with indoor and outdoor Netatmo cameras, to be used as connected internal unit. To use the home automation functions, configuration is not necessary. It is possible to display the MyHOME system status and control the integrated functions (lights, automation, scenarios, burglar alarm, temperature management, Nuvo music system, ...). Thanks to the "DOOR ENTRY for HOMETOUCH" application, available both for Android and iOS operating systems, it is also possible to manage the video door entry functions of a BTicino 2 wires system using the 7" capacitive display or the Smartphone.
003488 Flush mounted installation with box for masonry walls (item 003487) or wall mounted installation with the supplied metal bracket. Same as above but in White finish

003487 Box for flush mounted installation
Box for flush mounted installation of the HOMETOUCH Touch screen item 067259 or 003488. Width 197 mm, height 148 mm and depth 52 mm.

3487AP Support for flush mounted installation on plasterboard walls of the HOMETOUCH Touch screen 067259 or 003488.

F429 SCS/DALI interface
DALI dimmer, 8 independent outputs with maximum load 16 ballast at 230 Vac, pushbutton for load direct control - 6 DIN modules

F459 Driver manager
Integration platform with other brand systems - 6 DIN modules

Contact your Legrand Australian representative to check the feasibility of specific integrations and to request the licence needed to use the Driver manager.

App DOOR ENTRY for HOMETOUCH
This allows the user to manage the video internal unit calls locally and remotely using the smartphone or with a simple touch open the gate, activate the cameras and the video door entry answering machine.

App HOME + CONTROL for management of connected devices

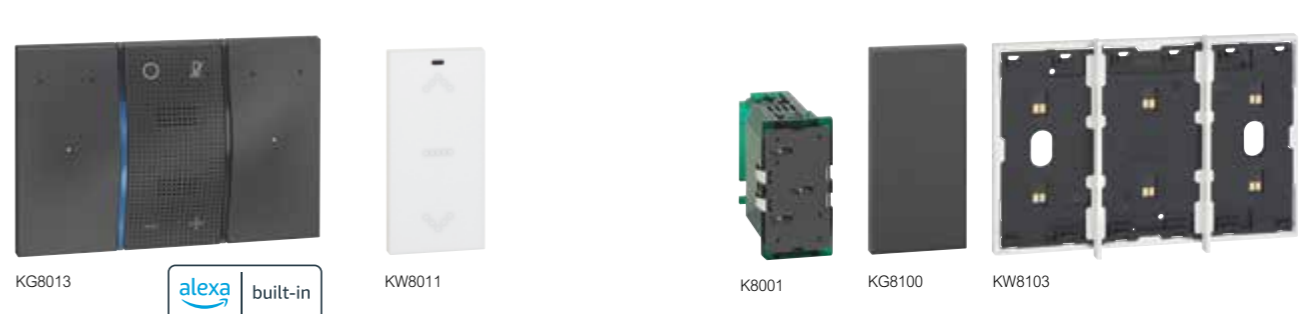

Voice control
 KW8013
 KW8013
Amazon Alexa digital control device with voice assistant, including two touch controls for lighting management.
27 Vd.c. power supply from BUS through connection module item KW8001 or additional power supply unit - 3 modules

Light control
 KW8010
 KW8010
Touch control for the management of ON/OFF light functions. One single control can manage from 1 to 2 functions between single lights, light groups or general lights. - 1 module

Full control
 KW8011
 KW8011
Touch control for the management from 1 to 3 functions between: lights on/off, load control, dimmer, shutters up/down with or without preset and scenarios. It can also be used as group or general control. It has on-board proximity sensor that allows the display of function icons/symbols when approaching the control - 1 module

Connection modules
 K8001
Device for the power supply of controls and actuators through BUS frame item KW/ KG8103, KW/KG8103P1, KW/KG8104, KW/KG8104P1

Blanking module
 KW8100
 KW8100
Cover for blanking module art. K4950 - 1 module

Frames for 3 and 4 module grids
 KW8103
 KW8103
BUS frame with intermediate control separators (removable). For the installation of up to 3 digital controls or covers, (item KW/KG8100) in 3-module box with support K4703AU



KW8103P1
 KW8103P1
BUS frame with intermediate control separators (removable). For the installation of up to 4 digital controls or covers, (item KW/KG8100) in 3-module box with support K4703AU



KW8104
 KW8104
BUS frame with intermediate control separators (removable). For the installation of up to 4 digital controls or covers, item (item KW/KG8100) in 4-module box with support K4704

KW8104P1
 KW8104P1
BUS frame with intermediate control separators (removable). For the installation of up to 5 digital controls or covers, (item KW/KG8100) in 4-module box with support K4704

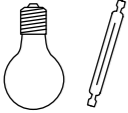
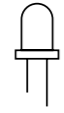

F411U2 F411/4

Cat. no.	Actuators for centralisations
○ F411U2	 <p>Actuator with 2 independent relays – for single and double loads: 10 A resistive and 6 A incandescence lamps, 500 W for reducer motors, 2 A $\cos\phi$ 0,5 for ferromagnetic transformers and 250 W for fluorescent lamps - logic relay interlock via configuration - it has "Zero crossing" technology - 2 DIN modules</p>
○ F411/4	 <p>Actuator with 4 independent relays - for single, double or mixed loads: 2 A resistive, 2 A incandescence lamps, 500 W for reducer motors, 2 A $\cos\phi$ 0,5 for ferromagnetic transformers and 70 W for fluorescent lamps - logic relay interlock via configuration - 2 DIN modules</p>

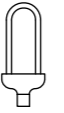
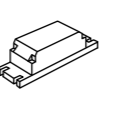
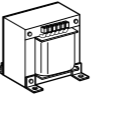
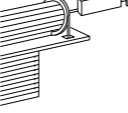

LOAD COMPATIBILITY (250 V~ 50/60 Hz)							
Actuators	Type						
							
	Energy saving incandescence and halogen lamps	LED lamps	Linear fluorescent lamps ¹⁾	Compact fluorescent lamps	Electronic transformers ³⁾	Ferromagnetic transformers ^{2) 3)}	Reducer motors for shutters ⁴⁾
F411U2	10 A 1380 W	250 W Max 4 lamps	4 A 230 W	250 W Max 4 lamps	4 A 230 W	4 A $\cos\phi$ 0,5 460 VA	2 A 460 W
F411/4	2 A 460 W	70 W Max 2 lamps	0.3 A 70 W	70 W Max 2 lamps	0.3 A 70 W	2 A $\cos\phi$ 0,5 460 VA	2 A 460 W

- Notes:**
- 1) Power factor corrected fluorescent lamps, discharge lamps.
 - 2) Account must be taken of the transformer yield to calculate the effective power of the load connected to the actuator. For example if a dimmer is connected to a 100 VA ferromagnetic transformer with yield 0.8, the effective power of the load will be 125 VA.
 - 3) The transformer must be loaded at its rated power and however never less than 90% of this power. It is preferable to use a single transformer rather than several transformers in parallel. For example it is better to use a single 250 VA transformer with 5 50W spotlights connected rather than use 5 50 VA transformers in parallel each with a 50 W spotlight.
 - 4) The  symbol on the actuators refers to the shutter reducer motors.



□ White colour cover ■ Black colour cover ○ Neutral item (without cover)



F413N F429 F418U2

Cat. no.	Dimmers for centralisations
○ F413N	 <p>1-output dimmer to supply fluorescent lamps or LED sources with input 1-10 V for single loads up to 2.5 A at 230 Va.c. – type of screw connection - power supply 27 Vd.c. – absorption 30 mA – max 10 ballast that can be connected (clamps 1-2) - with pushbutton for load direct control - version for fastening on DIN rail - 2 modules</p>
○ F429	 <p>DALI dimmer with 8 independent outputs for the connection of up to 16 DALI reactors for each output – 230 V a.c. power supply 50/60 Hz; 110 - 240 Vd.c. – absorption 5 mA - with pushbutton for load direct control - version for fastening on DIN rail - 6 modules</p>

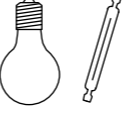
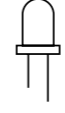
Cat. no.	Multi-load dimmers for centralisations
○ F418U2	 <p>Two-channel dimmer for the management of dimmer LEDs, dimmer compact fluorescent lamps (CFL), energy saving halogen lamps and electronic transformers at 110-230V. Possibility of parallelisation of the two channels to increase the maximum power which can be managed. power supply 27 Vd.c., absorption 18 mA - version for fastening on DIN rail - 4 modules</p>

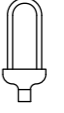
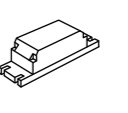
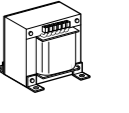
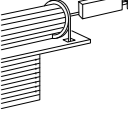
LOAD COMPATIBILITY (230 V~ 50/60 HZ)							
Actuators	Type						
							
	Energy saving incandescence and halogen lamps	LED lamps	Linear fluorescent lamps ¹⁾	Compact fluorescent lamps	Electronic transformers ³⁾	Ferromagnetic transformers ^{2) 3)}	Reducer motors for shutters ⁴⁾
F413N	-	-	2 A 460 W ⁵⁾ Max 10 ballast, type T5, T8, compact or driver for LED	-	-	-	-
F418U2	2x300 W	2x300 VA	-	2x300 VA	2x300 VA	2x300 VA	-
F429	SCS/DALI dimmer interface - 8 x16 ballast						

- Notes:**
- 1) Power factor corrected fluorescent lamps, discharge lamps. 2) Account must be taken of the transformer yield to calculate the effective power of the load connected to the actuator. For example if a dimmer is connected to a 100 VA ferromagnetic transformer with yield 0.8, the effective power of the load will be 125 VA.
 - 3) The transformer must be loaded at its rated power and however never less than 90% of this power. It is preferable to use a single transformer rather than several transformers in parallel. For example it is better to use a single 250 VA transformer with 5 50W spotlights connected rather than use 5 50 VA transformers in parallel each with a 50 W spotlight.
 - 4) The  symbol on the actuators refers to the shutter reducer motors.
 - 5) Only compatible with lamps with 1/10 V ballast.

□ White colour cover ■ Black colour cover ○ Neutral item (without cover)



KW4691 KG4691

Devices to be completed with appropriate cover as indicated below

Cat. no.	Thermostat
<input type="checkbox"/> KW4691 <input checked="" type="checkbox"/> KG4691	Probe with backlit display that controls the temperature of an individual zone. It features an input for the connection of a contact line (e.g. window contact). It can be used for the management of different types of systems, and the adjustment of the fan speed when fan coils are used. Possibility of automatic operation (summer/winter), with compatible systems - 2 modules White Black



F430/2 F430R8 F430V10

Cat. no.	Actuators
<input type="radio"/> F430/2	Actuator with 2 independent relays – for single and double loads: 6 A resistive, 2A motor driven valves and pumps - configuration based logic relay interlock - 2 DIN modules
<input type="radio"/> F430/4	Actuator with 4 independent relays - for single, double or mixed loads: 4 A resistive, 1 A motor driven valves, pumps and fan coils - configuration based logic relay interlock - 2 DIN modules
<input type="radio"/> F430R8	Actuator with 8 independent relays for the control of on-off valves, motorised valves (open-close and three points), pumps and fan coils with 2 and 4 tubes - 4A resistive, 1A motor valves, pumps and fan-coils- SCS-bus connection - 4 DIN modules
<input type="radio"/> F430R3V10	Actuator with 3 independent relays and 2 x 0-10 Volts outputs for the control of fan coils with 2 and 4 tubes with proportional 0-10 Volt valves - 4A resistive, 1A fan coil - SCS-BUS connection - 4 DIN modules
<input type="radio"/> F430V10	Actuator with 2 x 0-10 Volt outputs for the control of 0-10 proportional valves - SCS-BUS connection - 2 DIN modules



F520 3523 F521 F522 F523 3508BUS E49 3515

Cat. no.	Consumption display
<input type="radio"/> F520	Meter for the measurement of electricity on a maximum of 3 lines, by connecting 3 toroids to the appropriate inputs. Version for fastening on DIN rail - 1 module. The device is fitted with 1 toroid.
<input type="radio"/> 3523	Additional electricity meter toroid, item F520 and for actuator with sensor, item F522 for the measurement of the earth leakage current. Cable length 400 mm.
<input type="radio"/> F521	Load control management Central unit for the management and control of the actuators of the load control system, to prevent the risk of detachment of the limiter of the electricity supplier. The central unit manages up to 63 loads, a contract power between 1.5 and 18 kW, and tolerance up to +/- 20%. It integrates an electricity meter for the controlled line. Version for fastening on DIN rail - 1 module. The device is fitted with 1 toroid.
<input type="radio"/> F522	Actuator with integrated current sensor for the measurement of the controlled load consumptions. 1 relay - 10 A for incandescence lamps and 4 A for fluorescent lamps or ferromagnetic transformers, and 500 W for compact fluorescent and LED lamps - Bistable relay with zero crossing for the Automation and/or Load control management functions. Version for fastening on DIN rail - 1 module. Earth leakage control by connecting the additional toroid, item 3523.
<input type="radio"/> F523	1 relay actuator - for incandescence lamps and 4 A for fluorescent lamps or ferromagnetic transformers, and 500 W for compact fluorescent and LED lamps - bistable relay with zero crossing for the Automation and/or Load control management functions. Version for fastening on DIN rail - 1 module.

Cat. no.	Accessories
<input type="radio"/> 3508BUS	removable clamp for BUS connection - width 3.81 mm
<input type="radio"/> 3508U3	removable clamp 3 poles

Cat. no.	Power supplies
<input type="radio"/> E49	Compact power supply - input 230 Va.c. - output 27 Vd.c. Maximum current delivered 600 mA - 2 DIN modules.
<input type="radio"/> L4669	Connection cables Sheathed pair made up of 2 flexible wires with unshielded plaited sheath - insulation 300/500 V - complies with standards CEI 46-5 and CEI 20-20 - coil length 100 metres
<input type="radio"/> L4669/500	as above - in 500 m coils

System	Cable	
	L4669 - L4669/500 L4669KM1 - 336905	336904
Automation	•	•(1)
Energy Management/Consumption Display	•	•(1)
Temperature control	•	•(1)
Video door entry system		•

NOTE (1): for systems underground cable sections

Living Now
installation examples

EXAMPLE OF INSTALLATION OF THE LIGHT POINT WITH 1-MODULE COVER



EXAMPLE OF LIGHT POINT COMPOSITION

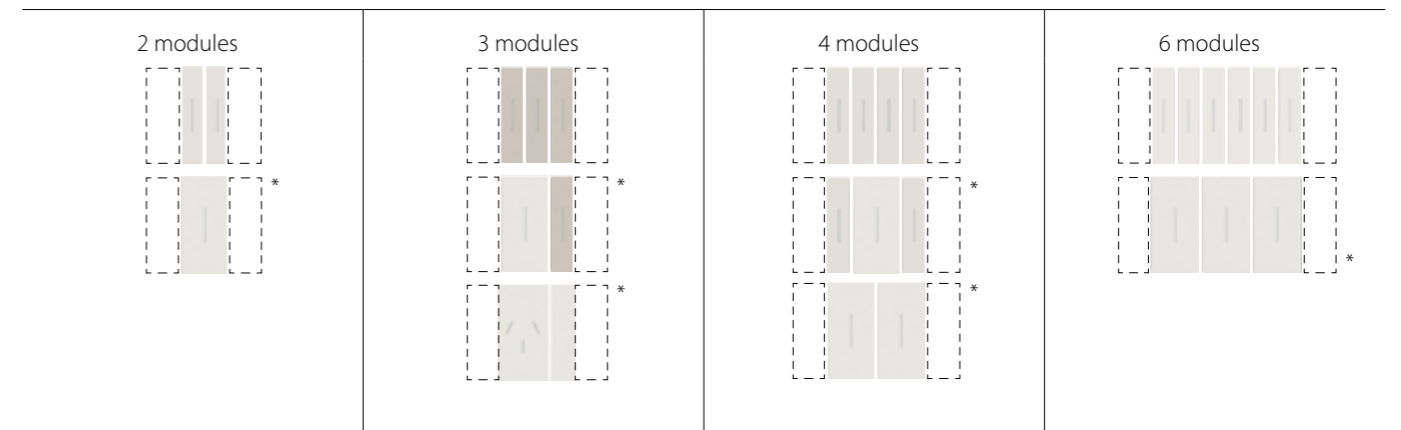

* Note: for solutions using one 2-module cover for the main controls, it will be necessary to use two "half-module blanking modules" (item K4949) at the sides of the control. (see the sample diagrams below)

Living Now



INSTALLATION AND COVER PLATE RANGE



INSTALLATION EXAMPLE OF THE DIGITAL CONTROLS

Installation with actuator in DIN switchboard

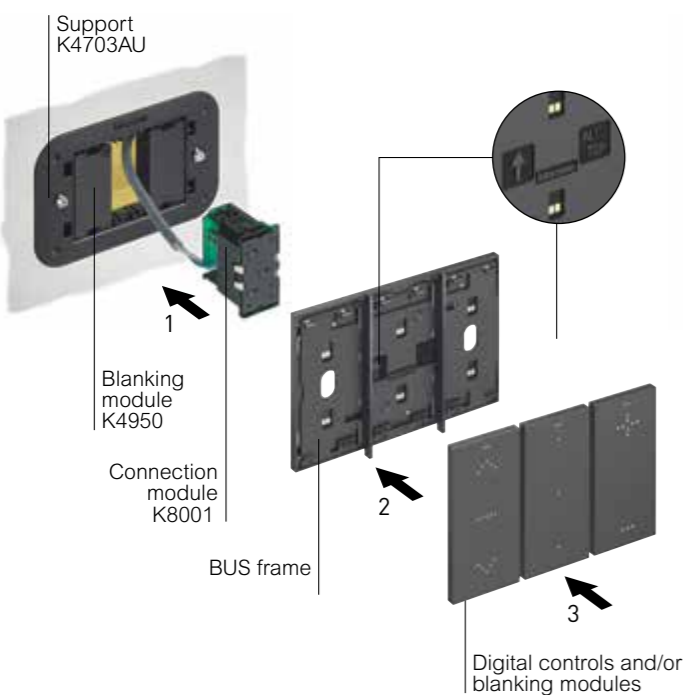

At the side of the connection module, install 2 blanking modules, item K4950, in any position.



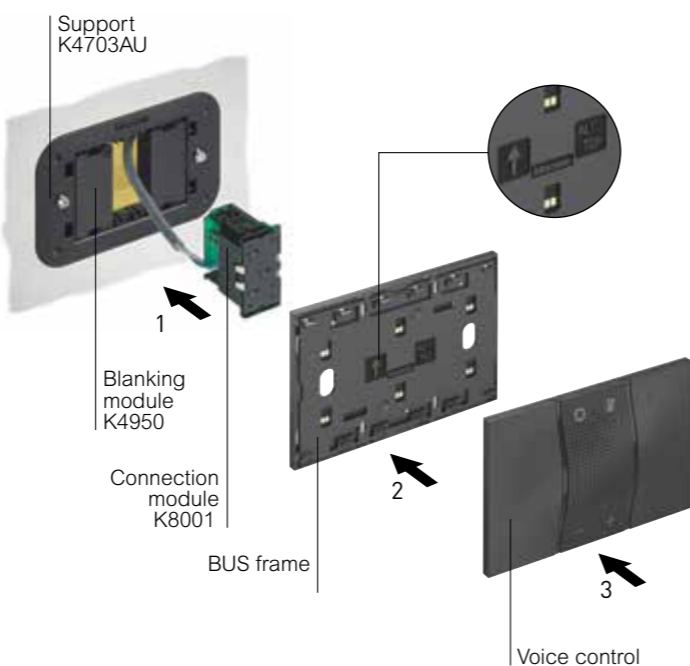



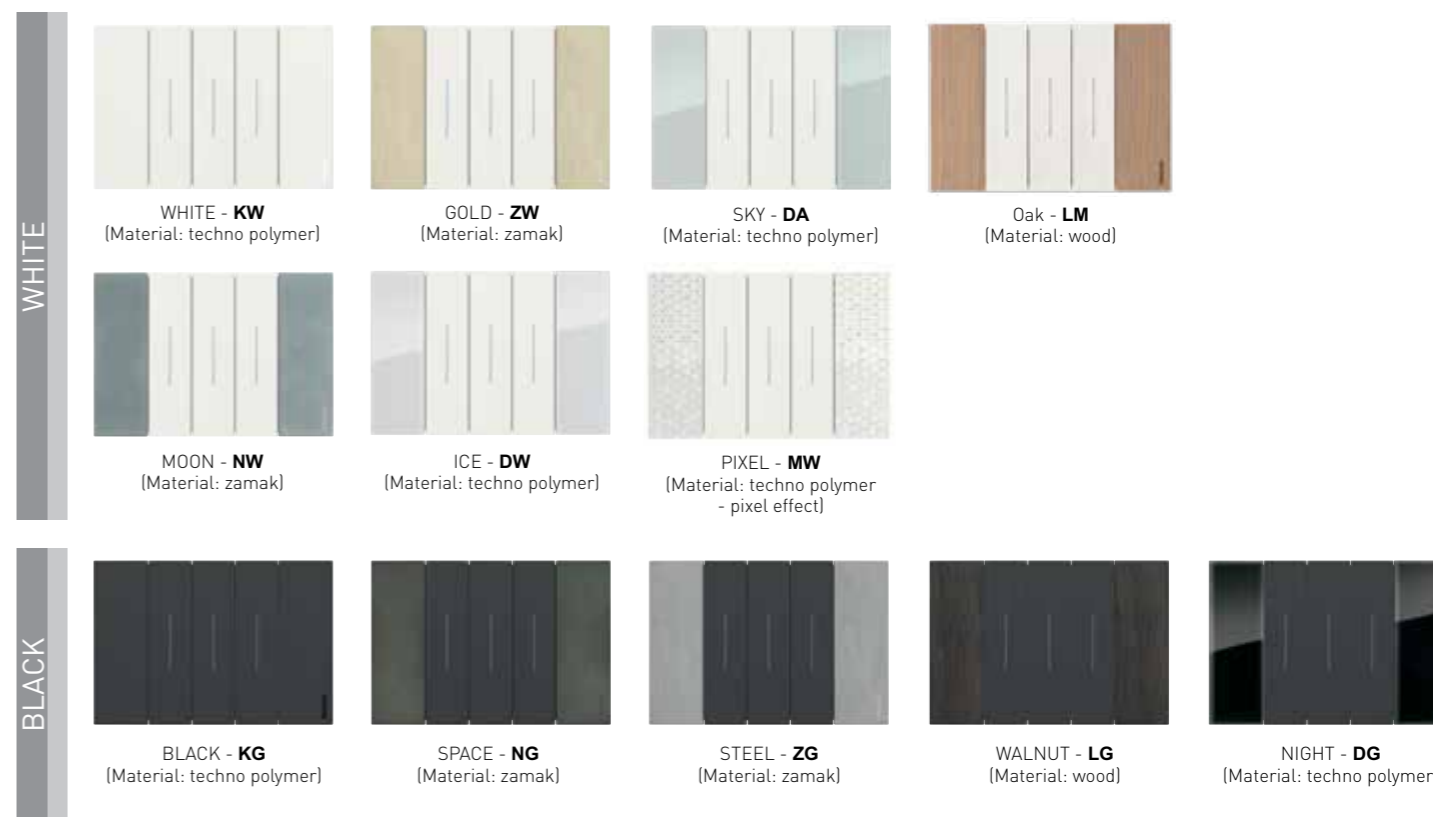













Installation of the voice control



Remove the finishing bars from the electrified frame.



SELECTION TABLE

						
Finish		DGPO	2 modules	3 modules/SGPO	4 modules	6 modules
	WHITE	KA4814KW	KA4802KW	KA4803KW	KA4804KW	KA4806KW
	GOLD	KA4814ZW	KA4802ZW	KA4803ZW	KA4804ZW	KA4806ZW
	MOON	KA4814NW	KA4802NW	KA4803NW	KA4804NW	KA4806NW
	ICE	KA4814DW	KA4802DW	KA4803DW	KA4804DW	KA4806DW
	SKY	KA4814DA	KA4802DA	KA4803DA	KA4804DA	KA4806DA
	PIXEL	KA4814MW	KA4802MW	KA4803MW	KA4804MW	KA4806MW
	OAK	KA4814LM	KA4802LM	KA4803LM	KA4804LM	KA4806LM
	BLACK	KA4814KG	KA4802KG	KA4803KG	KA4804KG	KA4806KG
	SPACE	KA4814NG	KA4802NG	KA4803NG	KA4804NG	KA4806NG
	STEEL	KA4814ZG	KA4802ZG	KA4803ZG	KA4804ZG	KA4806ZG
	WALNUT	KA4814LG	KA4802LG	KA4803LG	KA4804LG	KA4806LG
	NIGHT	KA4814DG	KA4802DG	KA4803DG	KA4804DG	KA4806DG
						
		Integrated in DGPO mechanism	K4702	K4703AU	K4704	K4706

Notes:

- The cover plate/cover combinations shown in these pages are purely indicative. Each cover plate can in fact be combined with covers of any colours, as required by the customer (white and black).
- The zamak and wood finishes are obtained using non-mass production procedures. The differences among the various cover plates are therefore a distinguishing valuable element.

Living Now
how to install the covers

LIGHT POINT INSTALLATION

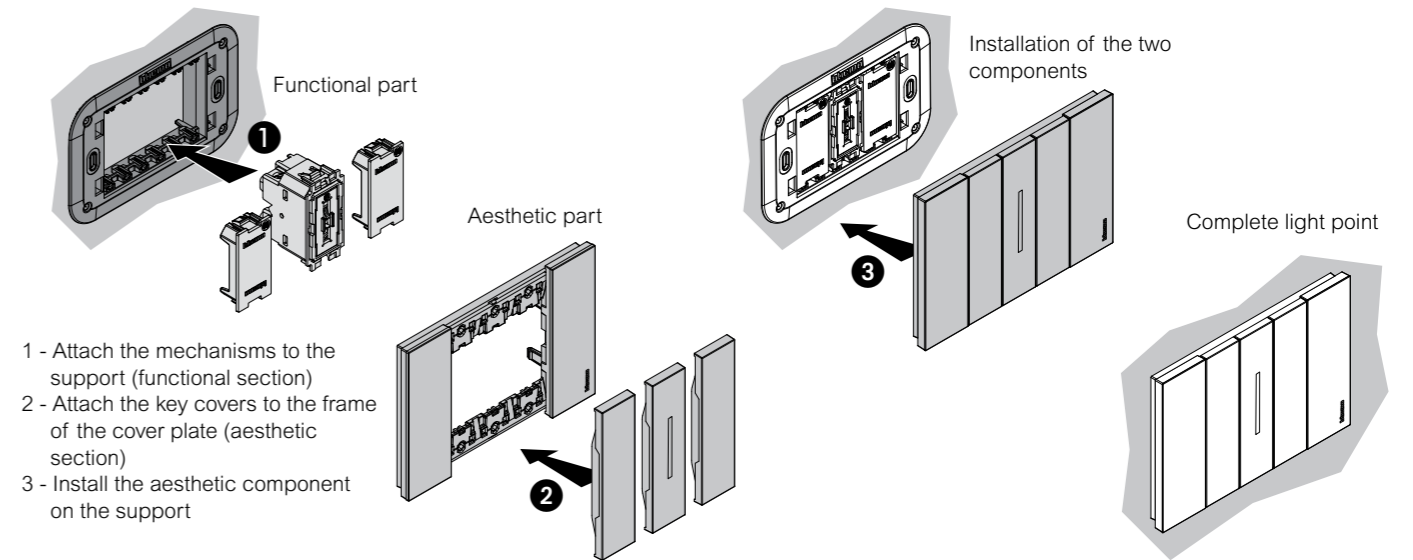

REMOVING KEY COVERS

Key covers are those that move in relation to the light point, to allow the activation of a control (traditional, connected)

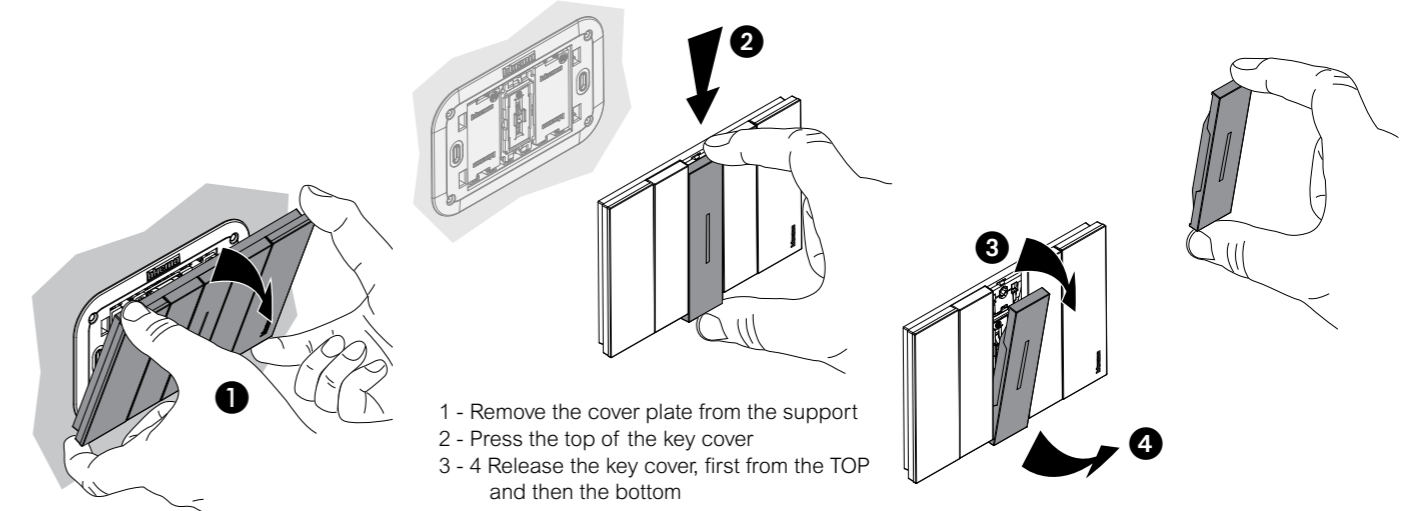

REMOVING FIXED COVERS

Fixed covers those are attached to the cover plates, such as for example blanking modules and all non-control devices (e.g. sockets, RJ connectors, TV sockets, USB chargers, etc.)

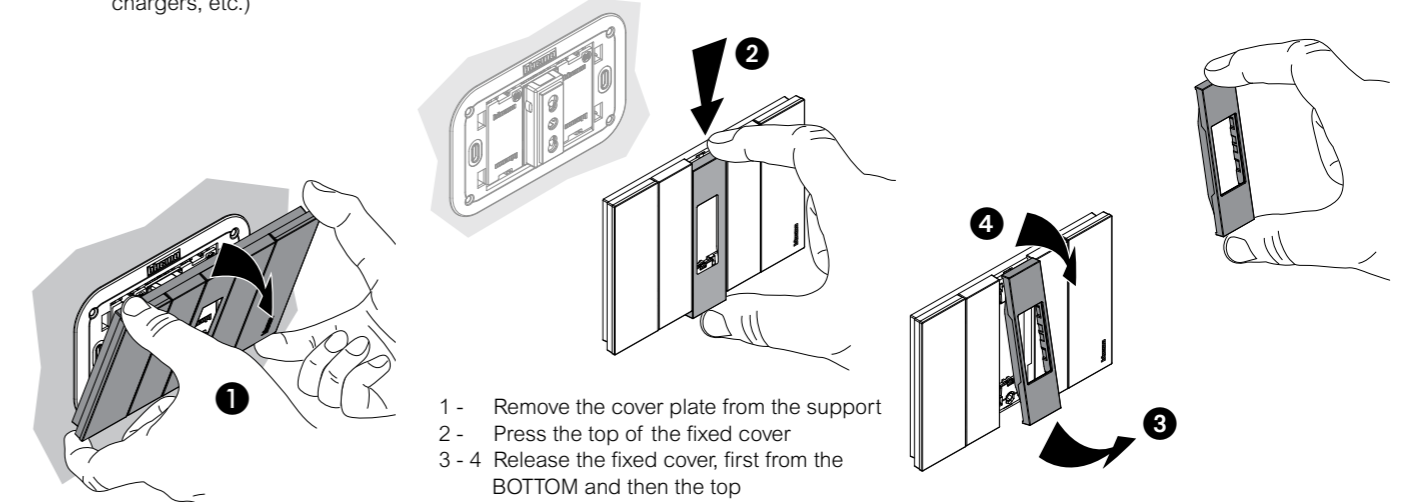

Living Now



**TECHNICAL INFORMATION,
DIMENSIONAL DATA**

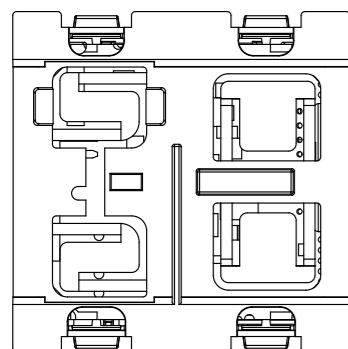

K4410
K4411

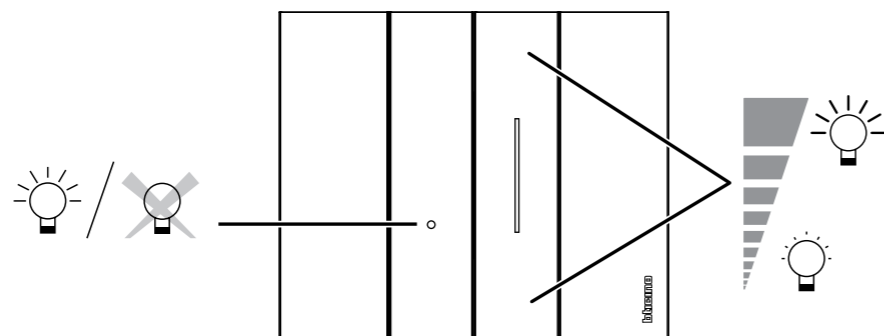

Switch the light on and off and bring the light to the desired level with a simple soft touch.
Possibility of setting different brightness levels.
ON/OFF notification LED.

DIMMER ITEM K4410 - LOAD COMPATIBILITY

		1-10 V		
240 V ~ 50/60 Hz	Max	600 VA	600 VA	600 VA
	Min.	20 VA	20 VA	20 VA

DIMMER ITEM K4411 - LOAD COMPATIBILITY

		R		L		C/L	
240 V ~ 50/60 Hz	Max.	400 W	400 W	400 VA	200 VA	400 VA	200 VA
	Min.	3 W	3 W	3 VA	3 VA	3 VA	3 VA

ELECTRONIC ROOM THERMOSTAT ITEM KW4441-KG4441

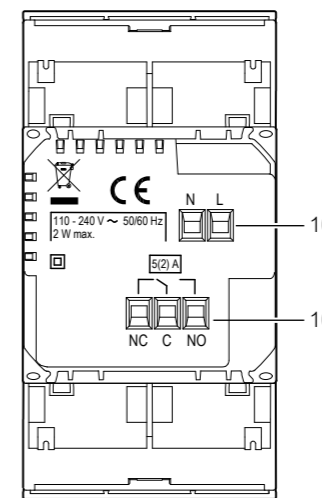
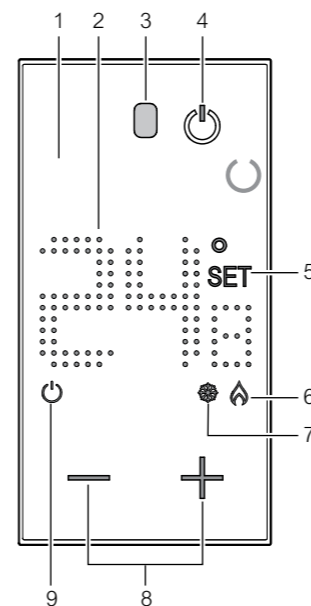

1. Backlit display
2. Temperature display
3. Lighting sensor
4. ON / OFF key sets the system (OFF) in anti-frost (7 °C) or heat-protection (35 °C) mode
5. Temperature setting indicator: appears when the temperature is being set
6. ON heating indicator
7. ON cooling indicator
8. Keys for temperature setting
9. OFF thermostat indicator
10. Connection clamps

Wiring diagrams

- System only for heating with clean contact (e.g. boiler activation) or heating and cooling with floor system

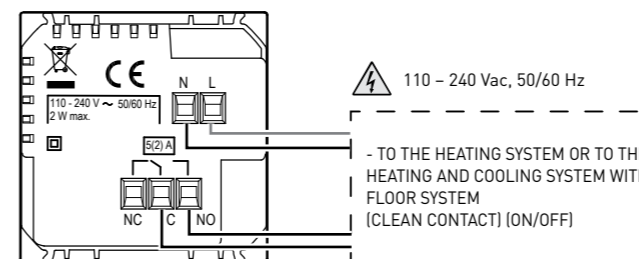

- Heating and cooling with different systems

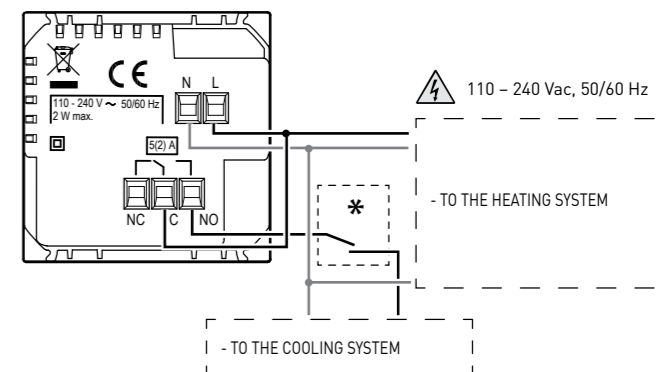

- System only for heating with load to be controlled to the mains voltage (e.g. 230Vac solenoid valve)

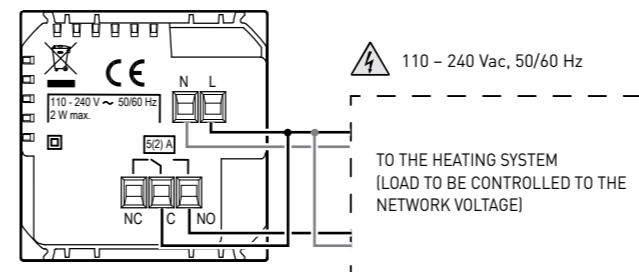

Technical features

Power supply	110 – 240 V ~, 50/60 Hz
Absorption	2 W max
Maximum cable section	1 x 1.5mm ²
Operating temperatures	5 – 40 °C
Setpoint temperature	5 – 40 °C; increase of 0.5 °C
Type of operation	1BU
Pollution index	2
Rated pulse voltage	4 kV
Contact output	5(2) A

Technical features for all devices

Technology: ZigBee certified product, Zigbee 3.0 public profile
 Performance: 200 m range in a free point-to-point field
 Band frequency: from 2.4 to 2.4835 GHz

CONNECTED TWO-WAY SWITCH ITEM K4003C

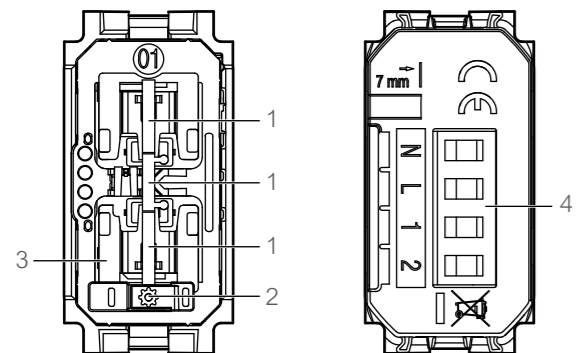

- 1 - Control pushbutton
- 2 - Setting pushbutton
- 3 - Notification LED
 - red steady: device not in Zigbee network
 - green steady: device in Zigbee network
- 4 - Connection clamps

Wiring diagram - interrupted

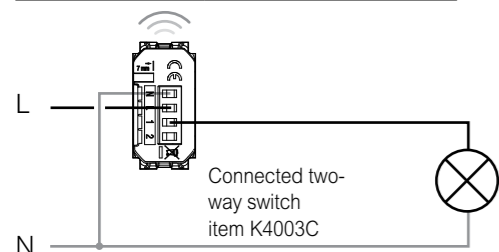

Wiring diagram - redirected or inverted

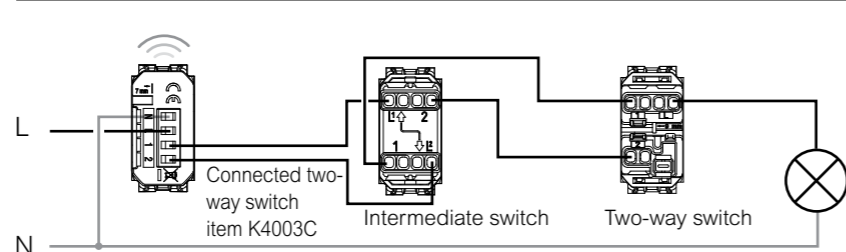

Load compatibility

 		LED 			
Loads	Filament lamp or halogen lamp	LED lamp	Fluorescent compact	Electronic transformer	Ferromagnetic transformer
240 V ~ 50/60 Hz	250 W	50 W	125 VA	125 VA	125 VA
Technology	ZigBee certified product, Zigbee 3.0 public profile				
Performances	200 m range in a free point-to-point field.				
Power level	REC 70-03: <20dBm				
Band frequency	from 2,4 to 2,4835 GHz				

DIMMER ITEM K4411C

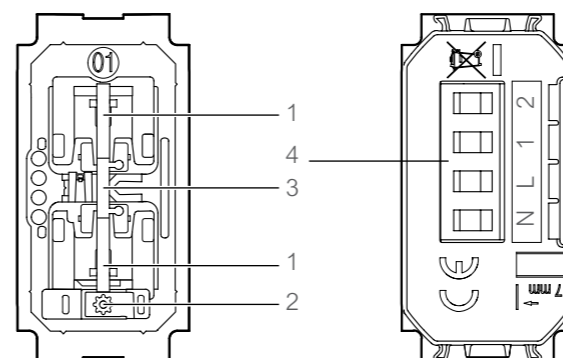

- 1 - Control pushbutton
- 2 - Reset pushbutton
- 3 - Notification LED
- 4 - Connection clamps

Basic diagram

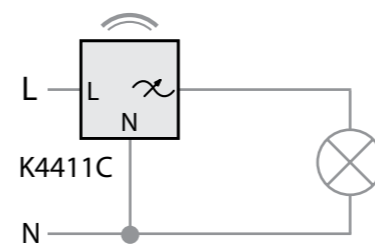
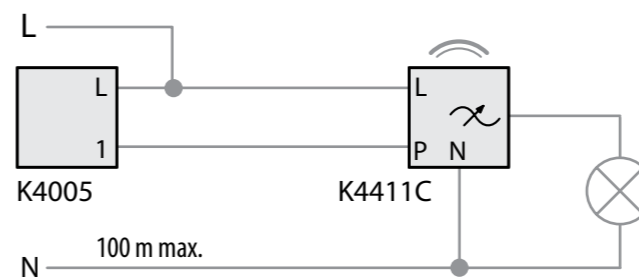

Diagram with remote control pushbuttons



Technical features

 		LED
Loads	Filament lamp or halogen lamp	LED lamp
240 VAC	150 W	150 W
100 VAC	75 W	75 W
Technology	Radio (Wireless meshed network)	
Power level	< 100 mW	
Band frequency	from 2,4 to 2,4835 GHz	

SHUTTERS CONTROL ITEM K4027C

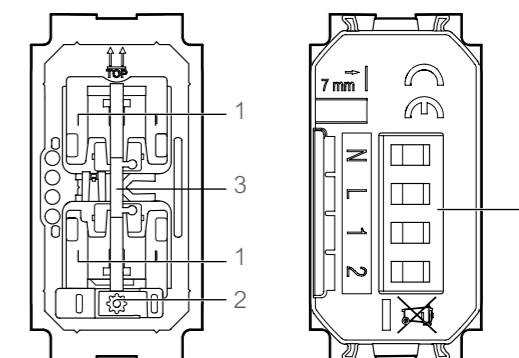

- 1 - Control pushbutton
- 2 - Reset pushbutton
- 3 - Notification LED
- 4 - Connection clamps

Wiring diagram - interrupted

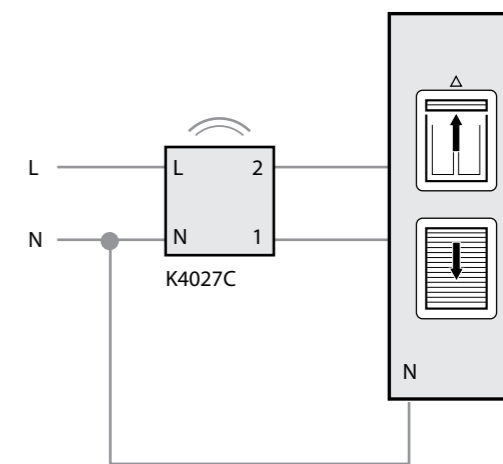

Warning: only compatible with standard motors (no pulse motors, no radio motors)

Technical features

Loads	Motor for shutters
240 VAC max.	1 x 500 VA
100 VAC max.	1 x 270 VA
Technology	Radio (Wireless meshed network)
Power level	< 100 mW
Band frequency	from 2,4 to 2,4835 GHz

CONNECTED LIGHT RELAY ITEM 574243

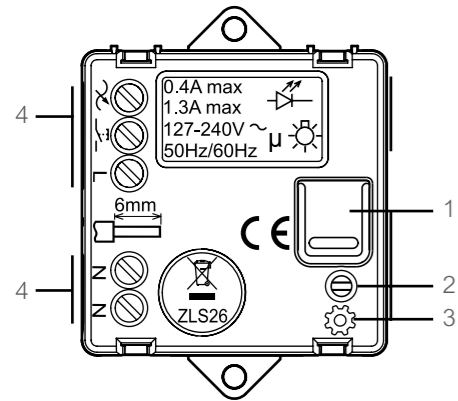

- 1 - Control pushbutton
- 2 - Setting pushbutton
- 3 - Notification LED
 - red steady: device not in Zigbee network
 - green steady: device in Zigbee network
- 4 - Connection clamps

Wiring diagram

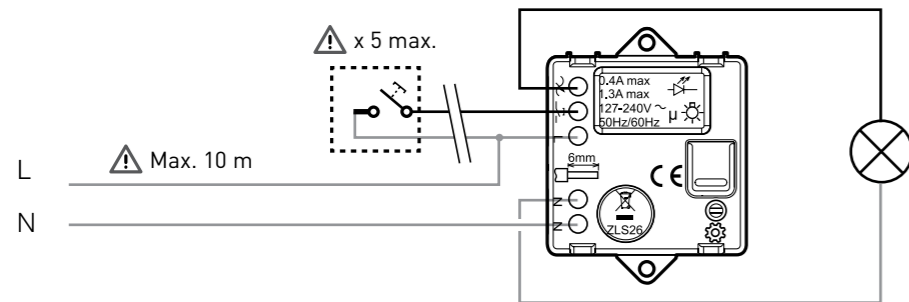

Option: remote control through mechanical pushbutton, not luminous.

Load compatibility

 	R	L			
Loads	Filament lamp or halogen lamp	LED lamp	Fluorescent compact	Electronic transformer	Ferromagnetic transformer
240 V ~ 50/60 Hz Max.	300 W	(*) 100 W	250 VA	250 VA	250 VA

* or 10 maxi. lamps

** warning: ferromagnetic transformers must be charged at over 60% of their rated power.

CONNECTED MODULE FOR SOCKET ITEM K4531C

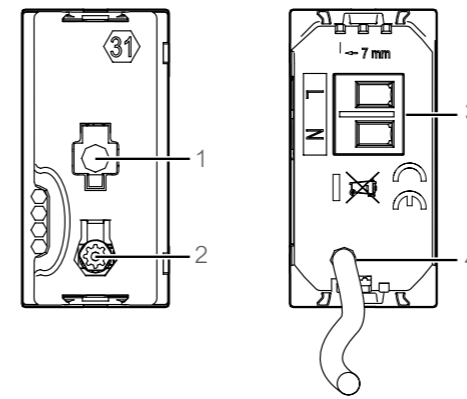

- 1 - notification LED
 - red steady: device not in Zigbee network
 - green steady: device in Zigbee network
- 2 - Setting pushbutton
- 3 - Connection clamps
- 4 - load controlled phase cable

Wiring diagram

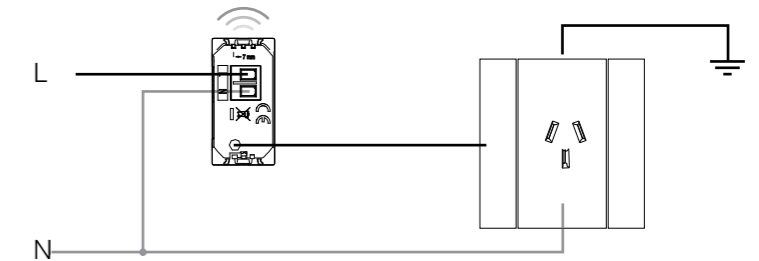

Load compatibility

Loads	Filament lamp	Halogen lamp	Electronic transformer	Ferromagnetic transformer	Fluorescent tube	Fluorescent compact	LED lamp	Ventilation motor
230 Va.c. 3800 W cos 0,8	16 A							

CONNECTED DIN METER ITEM 412015

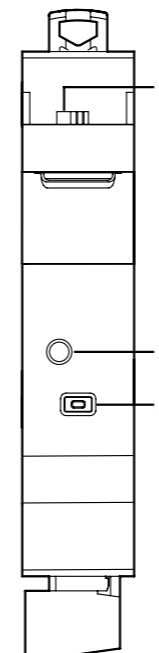

- 1 - Toroid connection
- 2 - notification LED
- 3 - Network association pushbutton

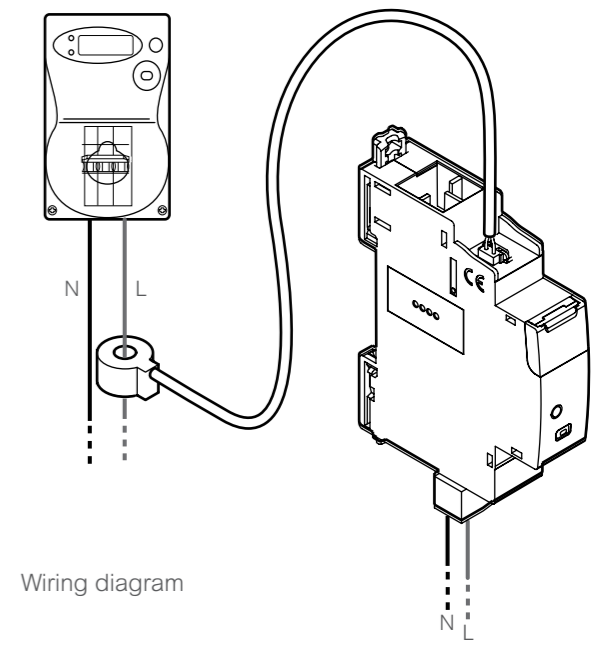

Wiring diagram

Living Now cover plates

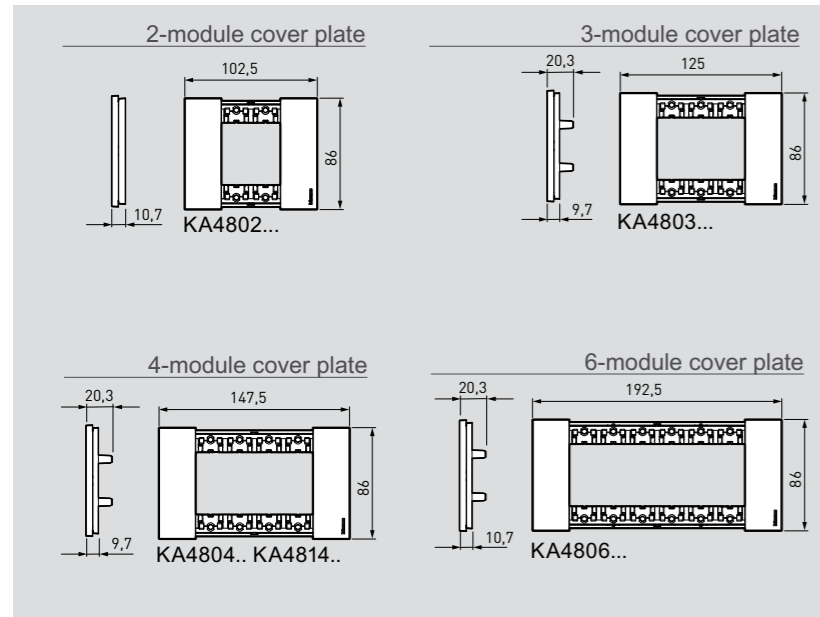

Living Now supports

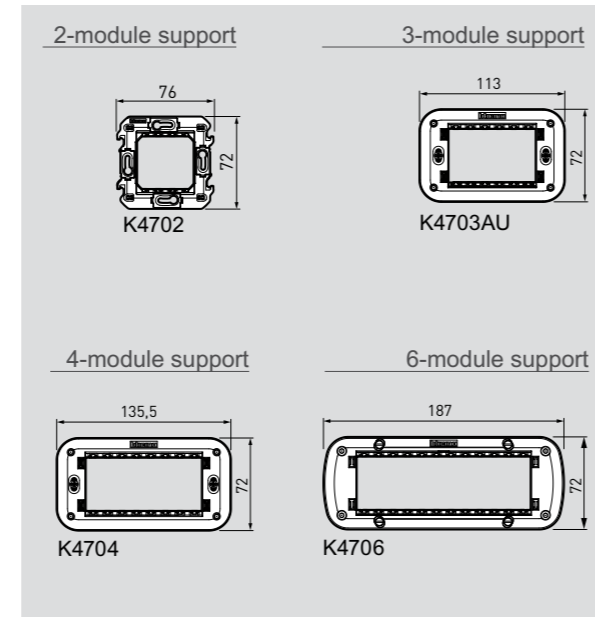

Living Now MyHOME BUS frames

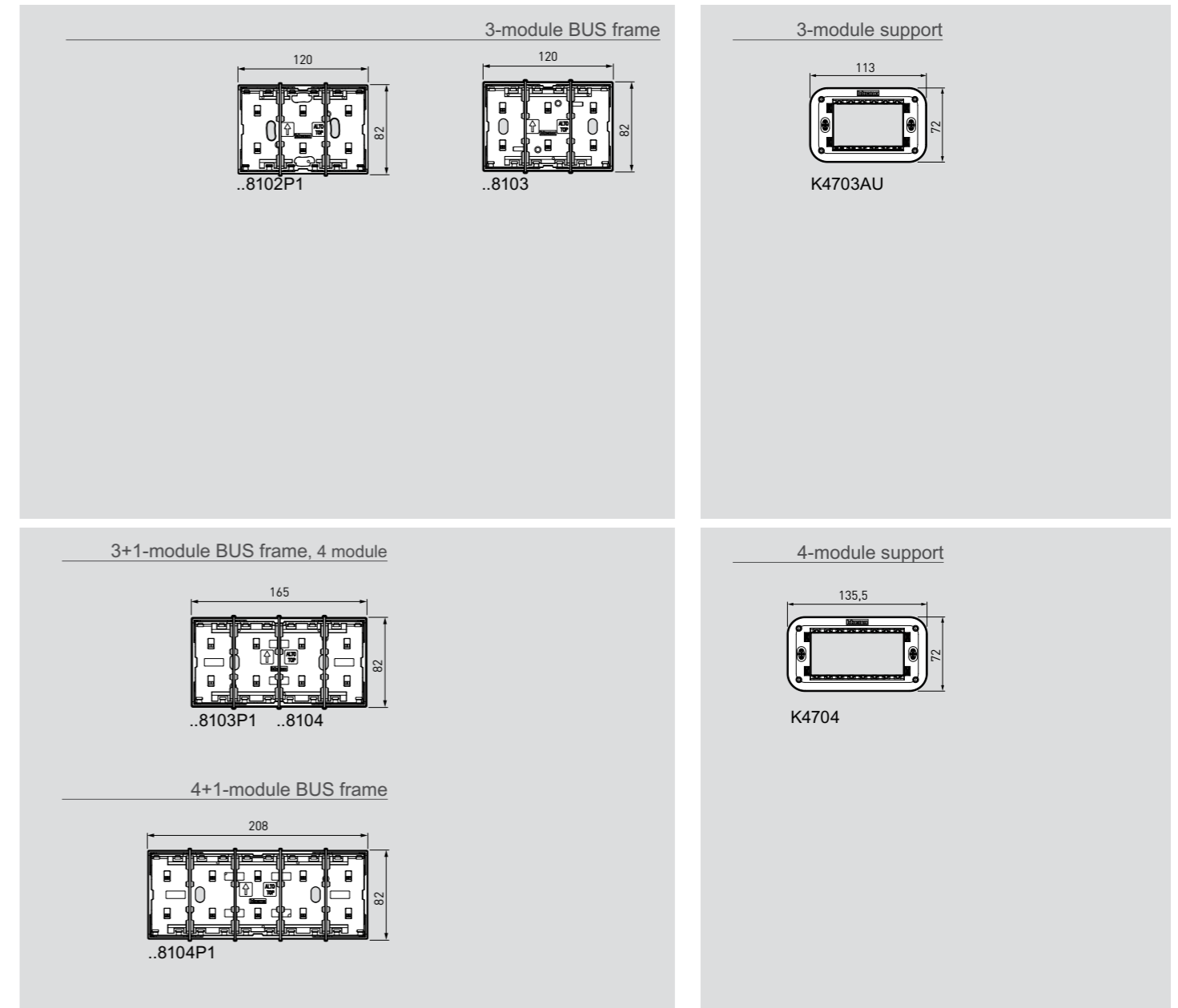

Smarter with Netatmo

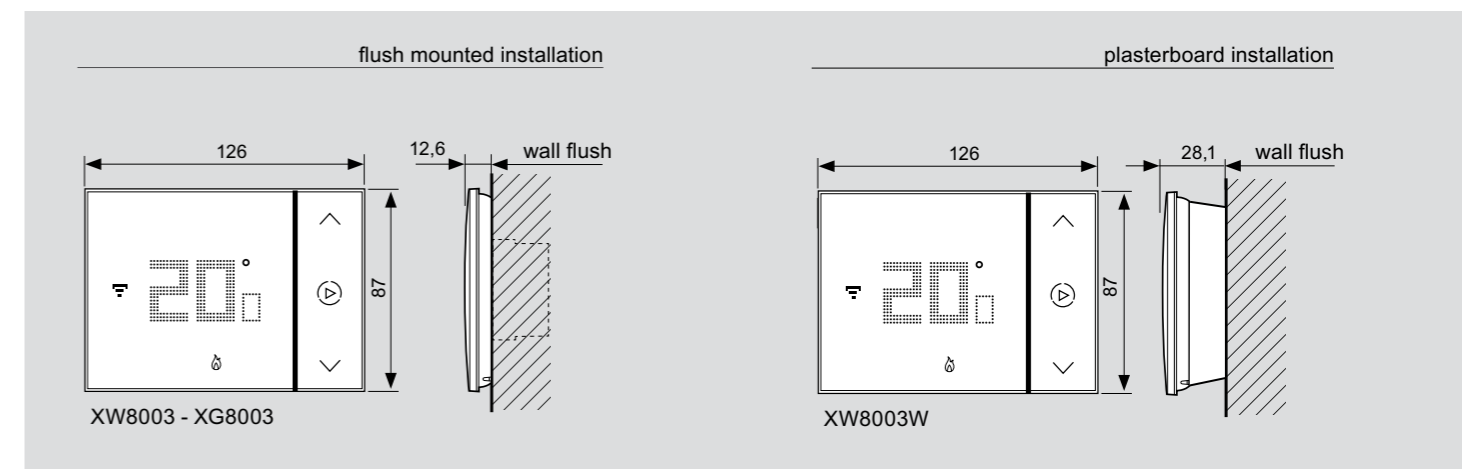

bticino



Legrand Australia

Building 4 Nexus Industry Park
43-47 Lyn Pde Prestons NSW 2170
1300 369 777
www.legrand.com.au

Legrand New Zealand

106-124 Target Road Glenfield
Auckland 0627 New Zealand
0800 476 009
www.legrand.co.nz

LE 63746 06/2023